

Operating Instructions

STEREO CD CASSETTE DECK RECEIVER

XR-J1500C

SPEAKER SYSTEM

S-J1500

COMPACT
disc
DIGITAL AUDIO

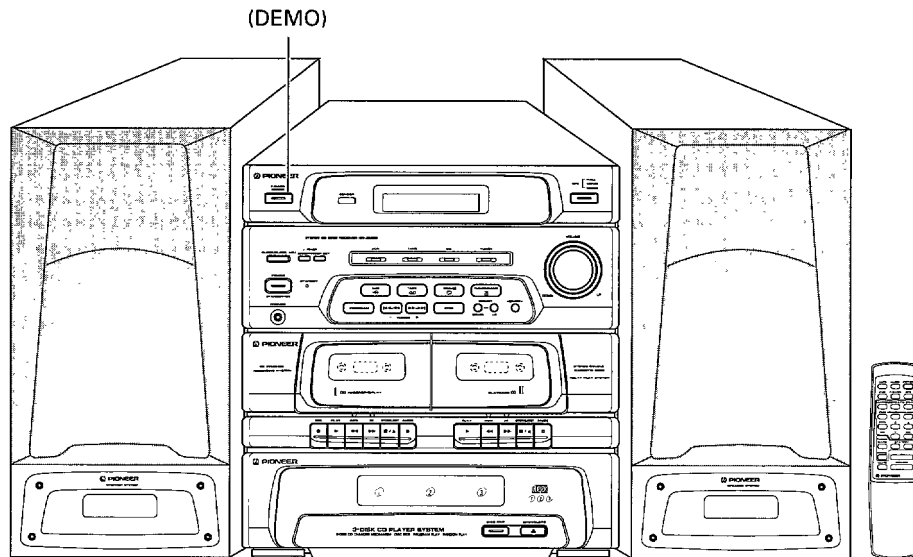

The speaker systems shown are those provided with the U.S., Canadian and Australian models.

Thank you for buying this Pioneer product.

Please read through these operating instructions so you will know how to operate your model properly. After you have finished reading the instructions, put them away in a safe place for future reference.

In some countries or regions, the shape of the power plug and power outlet may sometimes differ from that shown in the explanatory drawings. However, the method of connecting and operating the unit is the same.

WARNING: TO PREVENT FIRE OR SHOCK HAZARD, DO NOT EXPOSE THIS APPLIANCE TO RAIN OR MOISTURE.

[For Canadian model]

CAUTION: TO PREVENT ELECTRIC SHOCK DO NOT USE THIS (POLARIZED) PLUG WITH AN EXTENSION CORD, RECEPTACLE OR OTHER OUTLET UNLESS THE BLADES CAN BE FULLY INSERTED TO PREVENT BLADE EXPOSURE.

ATTENTION: POUR PREVENIR LES CHOCS ELECTRIQUES NE PAS UTILISER CETTE FICHE POLARISEE AVEC UN PROLONGATEUR UNE PRISE DE COURANT OU UNE AUTRE SORTIE DE COURANT, SAUF SI LES LAMES PEUVENT ETRE INSEREES A FOND SANS EN LAISSER AUCUNE PARTIE A DECOUVERT.

Demo Function

The Demo mode starts automatically when the power cord is plugged into the power outlet.

Also, when the P.BASS (DEMO) button is pressed in the STANDBY mode, the Demo mode is activated.

In the Demo mode, various functions of this system appear on the display.

- To cancel the demo mode, press either the P.BASS (DEMO) button or the POWER switch.

IMPORTANT NOTICE

[For U.S. and Canadian models]

The serial number for this equipment is located on the rear panel. Please write this serial number on your enclosed warranty card and keep it in a secure area. This is for your security.

This product complies with the Low Voltage Directive (73/23/EEC), EMC Directives (89/336/EEC, 92/31/EEC) and CE Marking Directive (93/68/EEC).

THE POWER SWITCH IS SECONDARY CONNECTED AND THEREFORE DOES NOT SEPARATE THE UNIT FROM MAINS POWER IN THE STANDBY POSITION.

IMPORTANT



The lightning flash with arrowhead, within an equilateral triangle, is intended to alert the user to the presence of uninsulated "dangerous voltage" within the product's enclosure that may be of sufficient magnitude to constitute a risk of electric shock to persons.



CAUTION:
TO PREVENT THE RISK OF ELECTRIC SHOCK, DO NOT REMOVE COVER (OR BACK). NO USER-SERVICEABLE PARTS INSIDE. REFER SERVICING TO QUALIFIED SERVICE PERSONNEL.



The exclamation point within an equilateral triangle is intended to alert the user to the presence of important operating and maintenance (servicing) instructions in the literature accompanying the appliance.

SAFETY INSTRUCTIONS

READ INSTRUCTIONS — All the safety and operating instructions should be read before the appliance is operated

RETAIN INSTRUCTIONS — The safety and operating instructions should be retained for future reference

HEED WARNING — All warnings on the appliance and in the operating instructions should be adhered to.

FOLLOW INSTRUCTIONS — All operating and use instructions should be followed

WATER AND MOISTURE — The appliance should not be used near water — for example, near a bathtub, washbowl, kitchen sink, laundry tub, in a wet basement, or near a swimming pool, etc

LOCATION — The appliance should be installed in a stable location

WALL OR CEILING MOUNTING — The appliance should not be mounted to a wall or ceiling.

VENTILATION — The appliance should be situated so that its location or position does not interfere with its proper ventilation. For example, the appliance should not be situated on a bed, sofa, rug, or similar surface that may block the ventilation openings; or, placed in a built-in installation, such as a bookcase or cabinet that may impede the flow of air through the ventilation openings

HEAT — The appliance should be situated away from heat sources such as radiators, heat registers, stoves, or other appliances (including amplifiers) that produce heat

POWER SOURCES — The appliance should be connected to a power supply only of the type described in the operating instructions or as marked on the appliance

POWER-CORD PROTECTION — Power-supply cords should be routed so that they are not likely to be walked on or pinched by items placed upon or against them. Pay particular attention to cords at plugs, convenience receptacles, and the point where they exit from the appliance

POLARIZATION — If your purchased product is provided with a polarized power plug, please read the following instructions. This product is equipped with a polarized alternating current line plug (a plug having one blade wider than the other). This plug will fit into the power outlet only one way. This is a safety feature. If you are unable to insert the plug fully into the outlet, try reversing the plug. If the plug should still fail to fit, contact your electrician to replace your obsolete outlet. Do not defeat the safety purpose of the polarized plug.

CLEANING — The appliance should be cleaned only with a polishing cloth or a soft dry cloth. Never clean with furniture wax, benzene, insecticides or other volatile liquids since they may corrode the cabinet.

POWER LINES — An outdoor antenna should be located away from power lines

NONUSE PERIODS — The power cord of the appliance should be unplugged from the outlet when left unused for a long period of time

OBJECT AND LIQUID ENTRY — Care should be taken so that objects do not fall and liquids are not spilled into the enclosure through openings

DAMAGE REQUIRING SERVICE — The appliance should be serviced by a Pioneer authorized service center or qualified service personnel when.

- The power-supply cord or the plug has been damaged.
- Objects have fallen, or liquid has been spilled into the appliance
- The appliance has been exposed to rain.
- The appliance does not appear to operate normally or exhibits a marked change in performance
- The appliance has been dropped or the enclosure damaged

SERVICING — The user should not attempt to service the appliance beyond that described in the operating instructions. All other servicing should be referred to qualified service personnel

OUTDOOR ANTENNA GROUNDING — If an outside antenna is connected to the antenna terminal, be sure the antenna system is grounded so as to provide some protection against voltage surges and built-up static charges.

In the U.S.A. section 810 of the National Electrical Code, ANSI/NFPA 70, provides information with respect to proper grounding of the mast and supporting structure, grounding of the lead-in wire to an antenna discharge unit, size of grounding conductors, location of antenna discharge unit, connection to grounding electrodes, and requirements for the grounding electrode. See Fig. A.

CART — An appliance and cart combination should be moved with care. Quick stops, excessive force, and uneven surfaces may cause the appliance and cart combination to overturn.



NEC — NATIONAL ELECTRICAL CODE

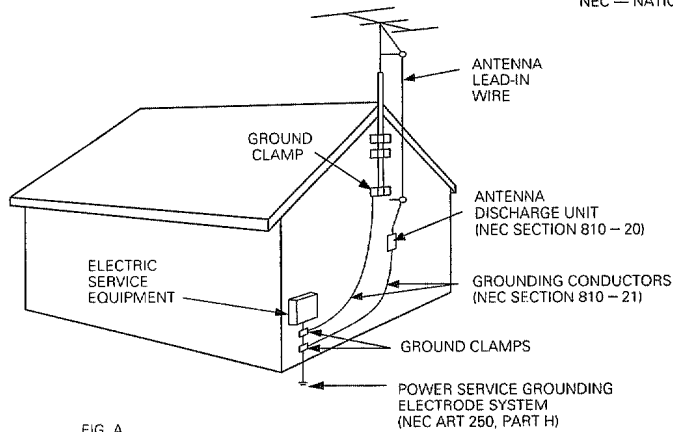

FIG A

[FOR EUROPEAN MODEL]

CAUTION

This product contains a laser diode of higher class than 1. To ensure continued safety, do not remove any covers or attempt to gain access to the inside of the product. Refer all servicing to qualified personnel.

The following caution label appears on your unit.
Location: rear of the unit



[For Canadian model]

This Class B digital apparatus meets all requirements of the Canadian Interference-Causing Equipment Regulations.

Information to User

Alteration or modifications carried out without appropriate authorization may invalidate the user's right to operate the equipment.

This equipment has been tested and found to comply with the limits for a Class B digital device, pursuant to Part 15 of the FCC Rules. These limits are designed to provide reasonable protection against harmful interference in a residential installation. This equipment generates, uses, and can radiate radio frequency energy and, if not installed and used in accordance with the instructions, may cause harmful interference to radio communications. However, there is no guarantee that interference will not occur in a particular installation. If this equipment does cause harmful interference to radio or television reception, which can be determined by turning the equipment off and on, the user is encouraged to try to correct the interference by one or more of the following measures:

- Reorient or relocate the receiving antenna.
- Increase the separation between the equipment and receiver.
- Connect the equipment into an outlet on a circuit different from that to which the receiver is connected.
- Consult the dealer or an experienced radio/TV technician for help.

[FOR U.S. MODEL]

CAUTION

- Use of controls or adjustments or performance of procedures other than those specified herein may result in hazardous radiation exposure.
- The use of optical instruments with this product will increase eye hazard.



Dear Customer:

Selecting fine audio equipment such as the unit you've just purchased is only the start of your musical enjoyment. Now it's time to consider how you can maximize the fun and excitement your equipment offers. This manufacturer and the Electronic Industries Association's Consumer Electronics Group want you to get the most out of your equipment by playing it at a safe level. One that lets the sound come through loud and clear without annoying blaring or distortion—and, most importantly, without affecting your sensitive hearing.

Sound can be deceiving. Over time your hearing "comfort level" adapts to higher volumes of sound. So what sounds "normal" can actually be loud and harmful to your hearing. Guard against this by setting your equipment at a safe level BEFORE your hearing adapts.

To establish a safe level:

- Start your volume control at a low setting.
- Slowly increase the sound until you can hear it comfortably and clearly, and without distortion.

Once you have established a comfortable sound level:

- Set the dial and leave it there.

Taking a minute to do this now will help to prevent hearing damage or loss in the future. After all, we want you listening for a lifetime.

We Want You Listening For A Lifetime

Used wisely, your new sound equipment will provide a lifetime of fun and enjoyment. Since hearing damage from loud noise is often undetectable until it is too late, this manufacturer and the Electronic Industries Association's Consumer Electronics Group recommend you avoid prolonged exposure to excessive noise. This list of sound levels is included for your protection.

Decibel

Level	Example
30	Quiet library, soft whispers
40	Living room, refrigerator, bedroom away from traffic
50	Light traffic, normal conversation, quiet office
60	Air conditioner at 20 feet, sewing machine
70	Vacuum cleaner, hair dryer, noisy restaurant
80	Average city traffic, garbage disposals, alarm clock at two feet.

THE FOLLOWING NOISES CAN BE DANGEROUS UNDER CONSTANT EXPOSURE

90	Subway, motorcycle, truck traffic, lawn mower
100	Garbage truck, chain saw, pneumatic drill
120	Rock band concert in front of speakers, thunderclap
140	Gunshot blast, jet plane
180	Rocket launching pad

Information courtesy of the Deafness Research Foundation.



REMOVAL OF PROTECTION CLAMPS

● Before using the CD player, be sure to perform the following procedure:

1. Remove the tape fixed at the bottom of the CD player.
2. Pull out the caution card and the CD tray will open.
3. When the CD tray opens, you will see two red transit protection clamps secured in the left and right tray. Remove the red transit protection clamps and the CD player is ready for use.

NOTES:

- Do not resecure the protection clamps each time you use the CD player.
- Always resecure the protection clamps and remove the CDs from the player before moving the unit.

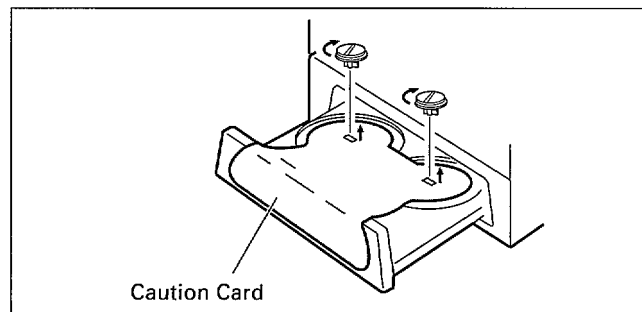

CONTENTS

REMOVAL OF PROTECTION CLAMPS	3
CAUTIONS REGARDING HANDLING	4
CONFIRM SUPPLIED ACCESSORIES	5
INSERTING BATTERIES INTO THE REMOTE CONTROL UNIT ...	5
REMOTE CONTROL OPERATIONS	5
CONNECTIONS	6
NAMES AND FUNCTIONS OF PARTS	8
SETTING THE CLOCK	12
TURNING ON THE POWER	12
Direct power on	12
TUNING INTO STATIONS	13
MEMORIZING STATIONS	14
Manual presetting	14
Station call	14
CAUTIONS REGARDING COMPACT DISC HANDLING	15
HOW TO HANDLE CASSETTE TAPES	15
LISTENING TO COMPACT DISCS	16
To play a compact disc	16
To stop playback	16
To search for a particular track	17
Time display	17
Selecting a different disc during play	17
Music (Intro) scan	18
Random playback - To play all tracks in random order	18
To repeat playback (repeat play)	18
TO PLAY ONLY DESIRED TRACKS ON A CD	19
Programmed playback - To program tracks in desired order	19
To clear all of the programmed contents	19
PLAYING TAPES	20
Basic operation	20
Continuous playback of two cassettes	21
RECORDING	21
Recording a radio broadcast onto a cassette tape	21
Copying a tape	22
Recording a CD onto a cassette tape	22
SOUND FIELD CONTROL OPERATION (SFC)	23
Selecting a preset sound setting	23
ADJUSTING THE SOUND	23
Boosting the bass sound	23
TIMER PLAYBACK	24
Setting the WAKE-UP timer	24
SLEEP TIMER	25
Sleep timer - Automatically turns off power	25
MAINTENANCE	25
TROUBLESHOOTING	26
SPECIFICATIONS	Back cover

VENTILATION

When installing this unit, make sure to leave space around the unit for ventilation to improve heat radiation (at least 30 cm at top, 15 cm at rear, and 15 cm at each side). If not enough space is provided between the unit and walls or other equipment, heat will build up inside, interfering with performance or causing malfunctions.

CAUTIONS REGARDING HANDLING

Location

Install the unit in a well-ventilated location where it will not be exposed to high temperatures or humidity.

Do not install the unit in a location which is exposed to direct rays of the sun or near hot appliances or radiators. Excess heat can adversely affect the cabinet and internal components. Installation of the unit in a damp or dusty environment may result in a malfunction or accident. (Also avoid installation near cookers, etc., where the unit may be exposed to smoke from steam or heat.)

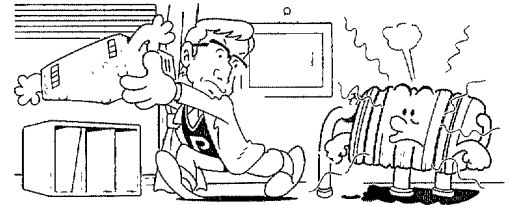

Precautions regarding installation

- Placing and using the unit for long periods on heat-generating sources will affect performance. Avoid placing the unit near heat-generating sources.
- Install the unit as far away as possible from your TV. Installation in close proximity to such equipment may cause noise degradation of the picture.
- Such noise may be particularly noticeable when an indoor antenna is used. In such cases, make use of an outdoor antenna or turn off the power of the unit.
- Please place this unit on a level surface.

Condensation

When this unit is brought into a warm room from previous cold surroundings or when the room temperature rises sharply, condensation may form inside and the unit may not be able to attain its full performance. To prevent this, allow the unit to stand for about an hour before switching it on or raise the room temperature gradually.

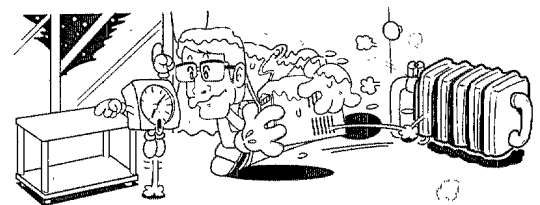

POWER-CORD CAUTION

Handle the power cord by the plug. Do not pull out the plug by tugging the cord and never touch the power cord when your hands are wet as this could cause a short circuit or electrical shock. Do not place the unit, a piece of furniture, etc., on top of the power cord or pinch the cord. Never make a knot in the cord or tie it with other cords. The power cords should be routed so that they are not likely to be stepped on. A damaged power cord can cause a fire or give you an electrical shock. Check the power cord once in a while. When you find it damaged, ask your nearest PIONEER authorized service center or your dealer for replacement.

CONFIRM SUPPLIED ACCESSORIES

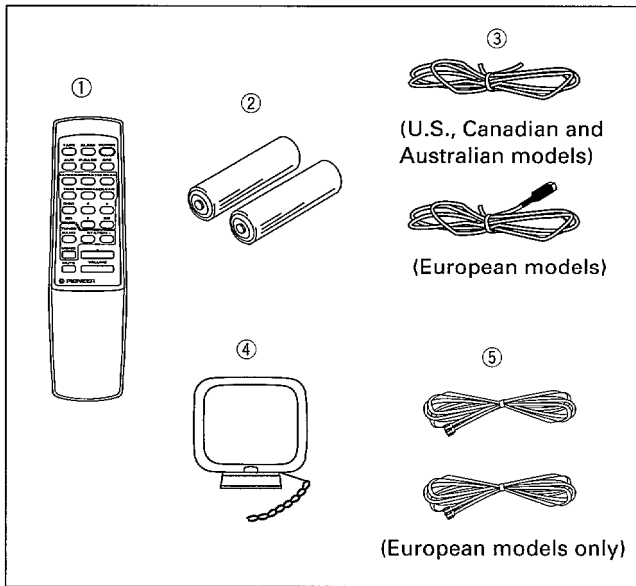

- ① Remote control unit x 1
- ② AAA/R03 dry cell batteries x 2
- ③ FM antenna x 1
- ④ AM loop antenna x 1
- ⑤ Speaker cords x 2 (included with speaker systems)
(European models only)

INSERTING BATTERIES INTO THE REMOTE CONTROL UNIT

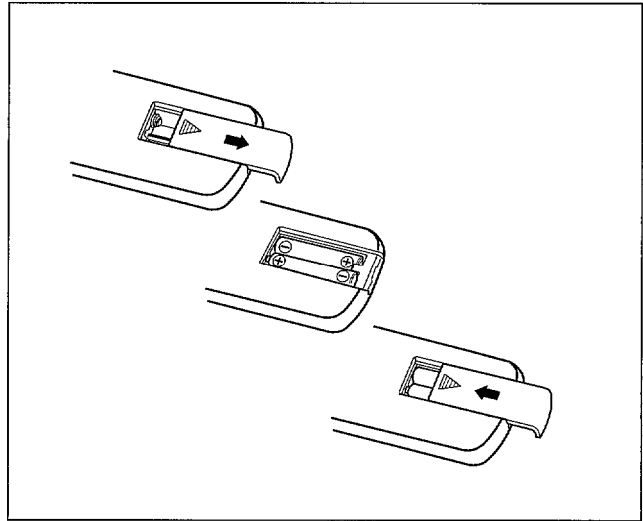

Open the battery compartment cover on the back of the remote control unit.

Insert size "AAA/R03" dry cell batteries into the battery compartment in accordance with the indications (\oplus , \ominus) inside the compartment.

Close the cover of the battery case.

Incorrect use of batteries may cause leakage or rupture. Always be sure to follow these guidelines:

- A. Always insert batteries into the battery compartment, correctly matching the positive \oplus and negative \ominus polarities, as shown by the display inside the compartment.
- B. Never mix new and used batteries.
- C. Batteries of the same size may have different voltages, depending on brand. Do not mix different brands of batteries.

REMOTE CONTROL OPERATIONS

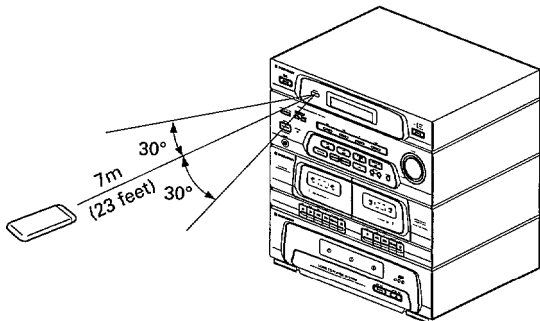

The remote control unit can be used within a range of approx. 7 meters (23 feet) from the remote sensor, and within angles of up to approx. 30 degrees.

NOTE:

If the remote control sensor window is in a position where it receives strong light such as sunlight or fluorescent light, control may not be possible.

CONNECTIONS

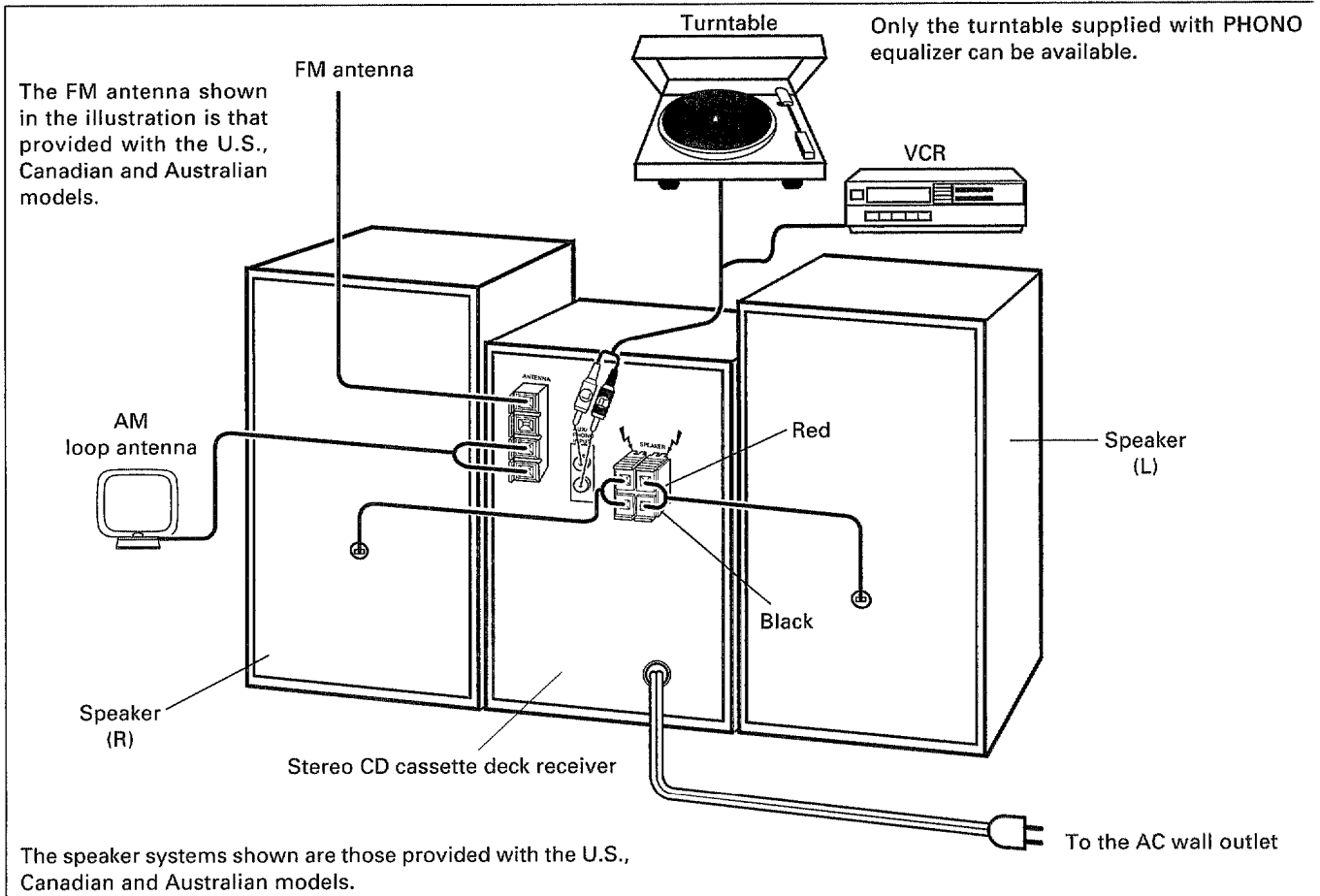

- Before making or changing the connections, switch off the power switch and disconnect the power cord from the AC outlet.
- Be sure to connect an antenna. If you do not, broadcast signal reception will not be possible.

1. Assemble the AM loop antenna.

- To permanently affix the antenna, screw the leg to a wall or other high location before assembling.

2. Connect the AM loop antenna and FM antenna to the unit's antenna terminals.

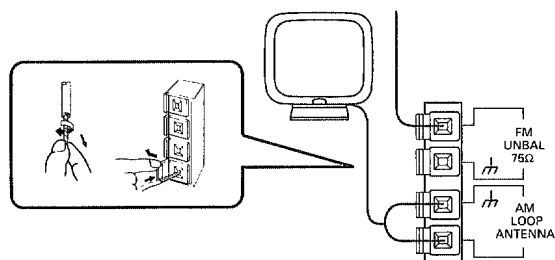

(U.S., Canadian and Australian models)

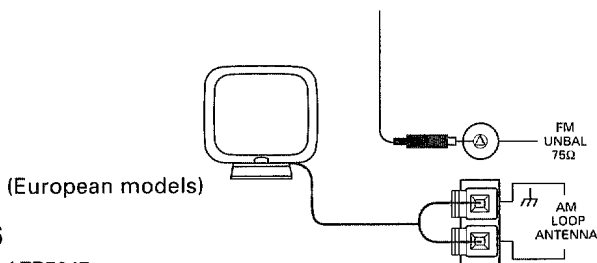

3. Connect the speaker cords to the SPEAKERS terminal

Connect the red cords to the "+" (red) terminals and the bl cords to the "-" (black) terminals. Connect the cords to the speakers in nearly the same way (European models only).

- ① Twist the wire strands.
- ② Push away the tab and insert the cord into the terminal.
- ③ Pull back the tab. Be sure to tighten the cords firmly.

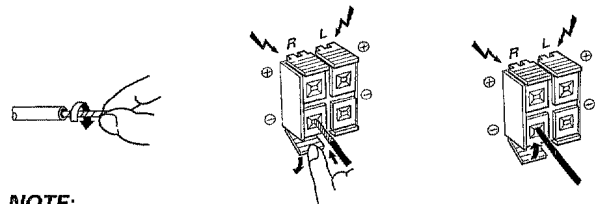

NOTE:

Do not allow the conductors of the cords to project out of terminals or to come into contact with other conductors. Breakdown or failure may occur when conductors touch.

Speaker impedance

Connect speaker systems with a nominal impedance range from 6 Ω to 16 Ω.

Precautions for the S-J1500

- Do not connect to any amplifier other than the one supplied with this system. Connection to any other amplifier may, in rare cases, result in smoke or fire.
- Be careful not to block the port opening on the front panel of the speaker.
- This speaker system is not magnetically shielded, and may cause color noise or distortion when placed very near a television set. If this occurs, place the speakers farther away from the television set.

4. When using the VCR or turntable, connect the audio cable to the AUX/PHONO input jacks.

(Only the turntable supplied with PHONO equalizer can be available.)

5. Finally, plug the power cord into the AC wall outlet.

NOTE:

Insert the plugs securely into the jacks. Improper connection can lead to sound distortion or malfunction.

Antenna connections

Radio reception is not possible unless the antenna is properly connected.

The strength of broadcast signals varies from one area to another. Signal propagation is especially poor in metropolitan areas, where there are many tall buildings and in mountainous areas. Proper antenna installation is vital to good reception.

FM ANTENNA

Stretch out the antenna and affix it to a wall, etc.

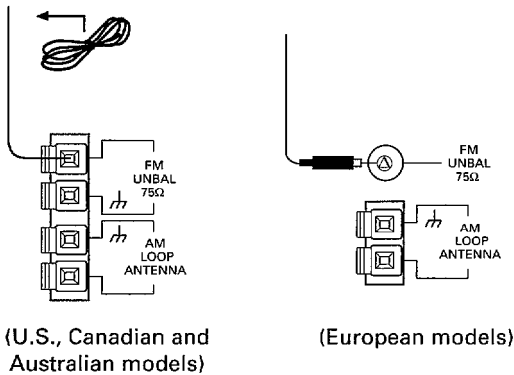

External FM antenna installation

Use an external antenna when the signals from the stations are weak and cannot be picked up by the accessory FM antenna or when the sound heard is accompanied by too much noise.

When the connecting cable is a 75 Ω coaxial cable.

(U.S., Canadian and Australian models only)

Connect a 75 Ω coaxial cable.

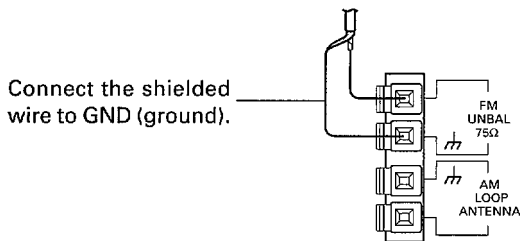

AM ANTENNA

The antenna should be placed at a distance from this unit, and should not be allowed to touch metallic objects. Avoid placing it near CD players, personal computers, television sets and other devices generating radio frequencies.

Setting up the AM antenna

There are two ways of setting up the AM antenna.

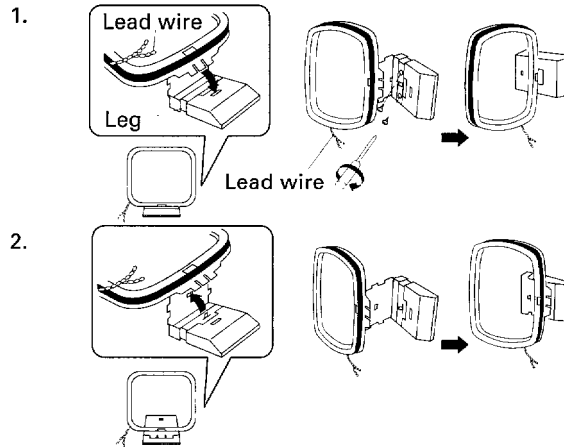

- Insert the claw on the bottom of the antenna into the groove on the leg.
- Use the attachment hole in the leg to screw to a wall or other location, then insert the claw on the bottom of the antenna into the groove in the leg (affixing the antenna in the direction that gives the best reception).
- Place the antenna on a level surface and rotate it to locate the orientation that yields the best reception.

External AM antenna

Indoor AM antenna

Provide a vinyl-coated wire [5 to 6 meters (17 to 20 feet) long]. Secure one end to the AM terminal and the other end to a wall or other high location.

Outdoor AM antenna

If reception is still poor even when a lead antenna has been fully extended indoors, stretch out a vinyl-coated wire and secure it outdoors.

NOTES:

- Do not detach the AM loop antenna when using the external AM antenna.
- ⚡ (signal earth) is designed to reduce noise that occurs when an antenna is connected. It is not a safety earth.

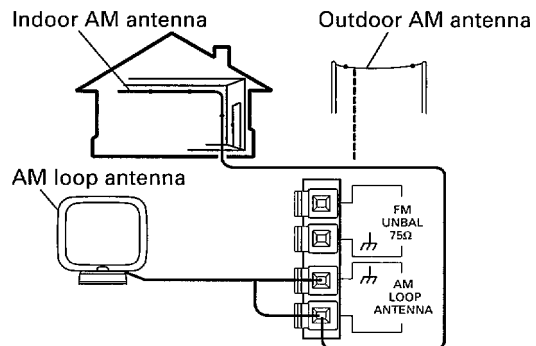

This illustration shows U.S., Canadian and Australian models.

NAMES AND FUNCTIONS OF PARTS

RECEIVER section

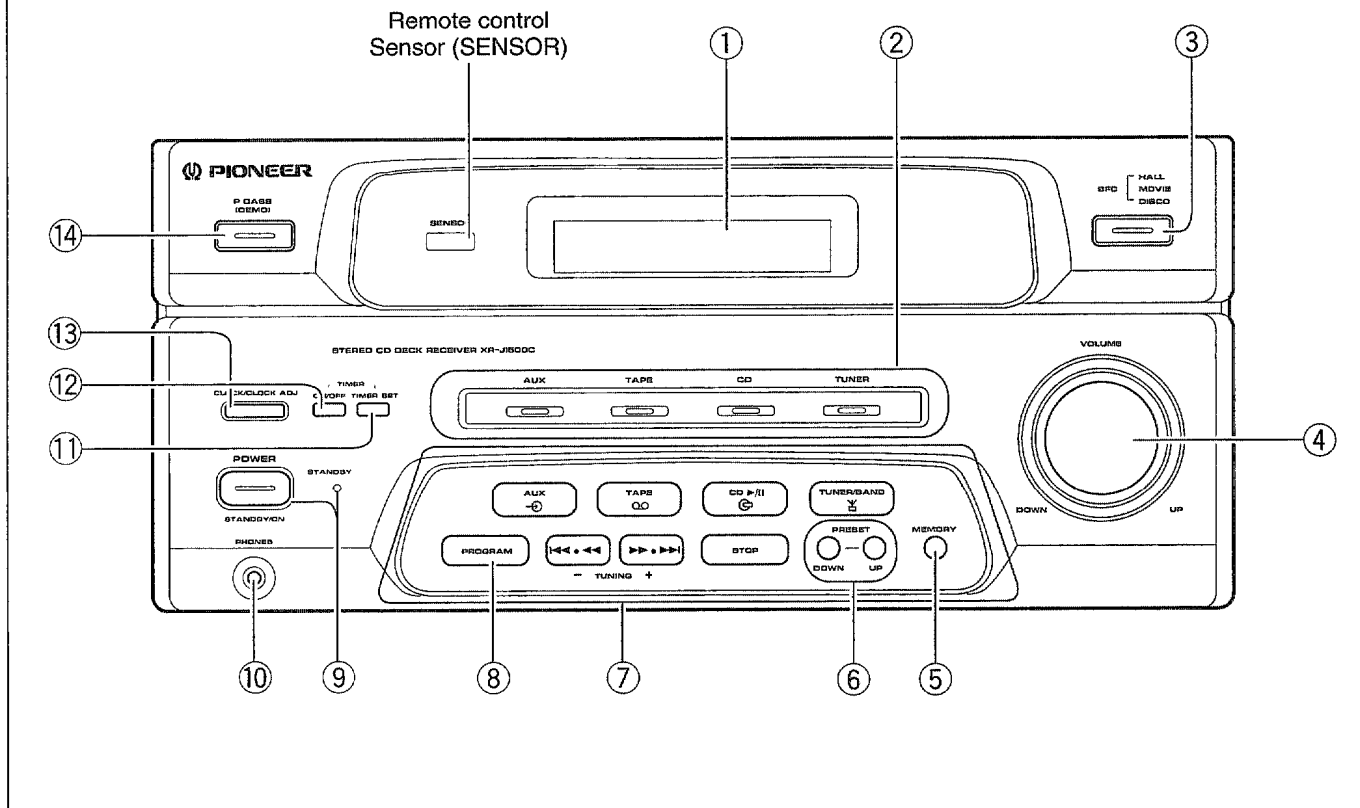

RECEIVER section

① DISPLAY

② FUNCTION indicators

③ SFC button [P.23](#)

Each time this button is pressed, the mode changes in the following sequence.

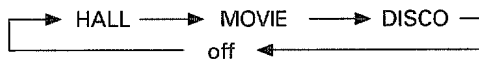

④ VOLUME control

⑤ MEMORY button [P.14](#)

⑥ PRESET DOWN/UP buttons [P.14](#)

⑦ FUNCTION buttons

⑧ PROGRAM button [P.19](#)

⑨ POWER switch/STANDBY indicator

This is the switch for electric power.

ON : When set to the ON position, power is supplied and the unit becomes operational.

STANDBY : When set to the STANDBY position, the power flow is cut and the unit is no longer operational. A minute flow of power feeds the unit to maintain operation readiness. The STANDBY indicator lights.

⑩ Headphones jack

⑪ TIMER SET button [P.24](#)

⑫ TIMER ON/OFF button [P.24](#)

⑬ CLOCK/CLOCK ADJ button [P.12](#)

⑭ P.BASS (DEMO) button [P.23](#)

Set to ON to produce powerfully enhanced bass sound.

TAPE DECK & CD PLAYER section

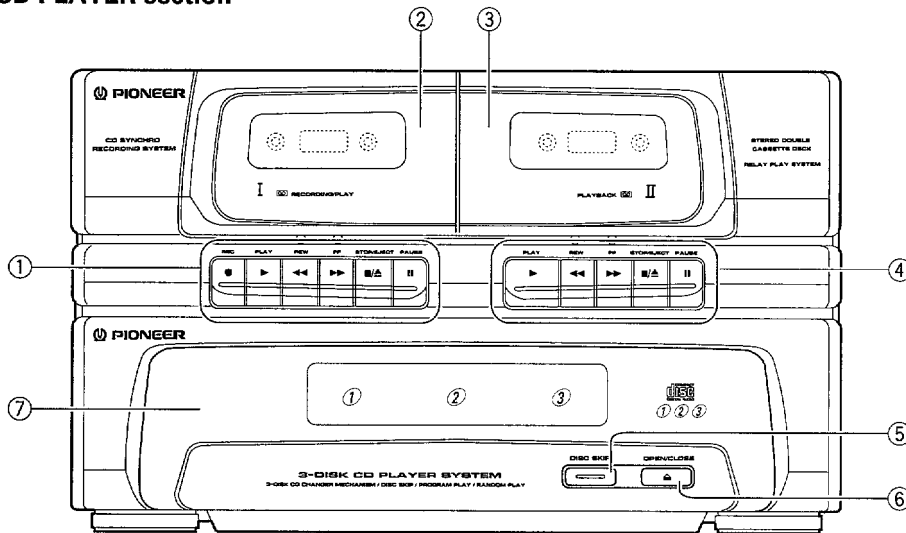

FUNCTION button section

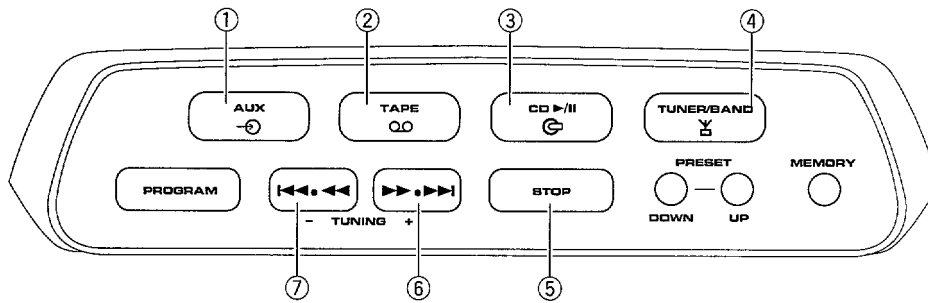

TAPE DECK & CD PLAYER section

- ① DECK I operation buttons
(Recording ●, Play ►, Fast ◀◀▶▶, Stop/Eject ■/▲, Pause II)
- ② DECK I cassette door
- ③ DECK II cassette door
- ④ DECK II operation buttons
(Play ►, Fast ◀◀▶▶, Stop/Eject ■/▲, Pause II)
- ⑤ DISC SKIP button **P.19**
- ⑥ OPEN/CLOSE (▲) button
- ⑦ CD tray

FUNCTION button section

- ① AUX button and indicator
- ② TAPE button and indicator
- ③ CD (►/II) button and indicator
- ④ TUNER/BAND button and indicator
- ⑤ Stop button
- ⑥ ►► • ►► button
- ⑦ ◀◀ • ◀◀ button

● Roles of the common operation buttons. (The roles of the buttons vary depending on the input functions as shown below.)

During tuner operation

- • ►► : Frequency + (up) button
- ◀◀ • ◀◀ : Frequency - (down) button

During CD input

- • ►► : Forward Manual/Track Search button
- ◀◀ • ◀◀ : Reverse Manual/Track Search button

AUTO FUNCTION SELECTOR

The amplifier in this unit employs an auto function selector; by merely beginning playback on CD player or tuner causes the amplifier to automatically select the respective function.

NAMES AND FUNCTIONS OF PARTS

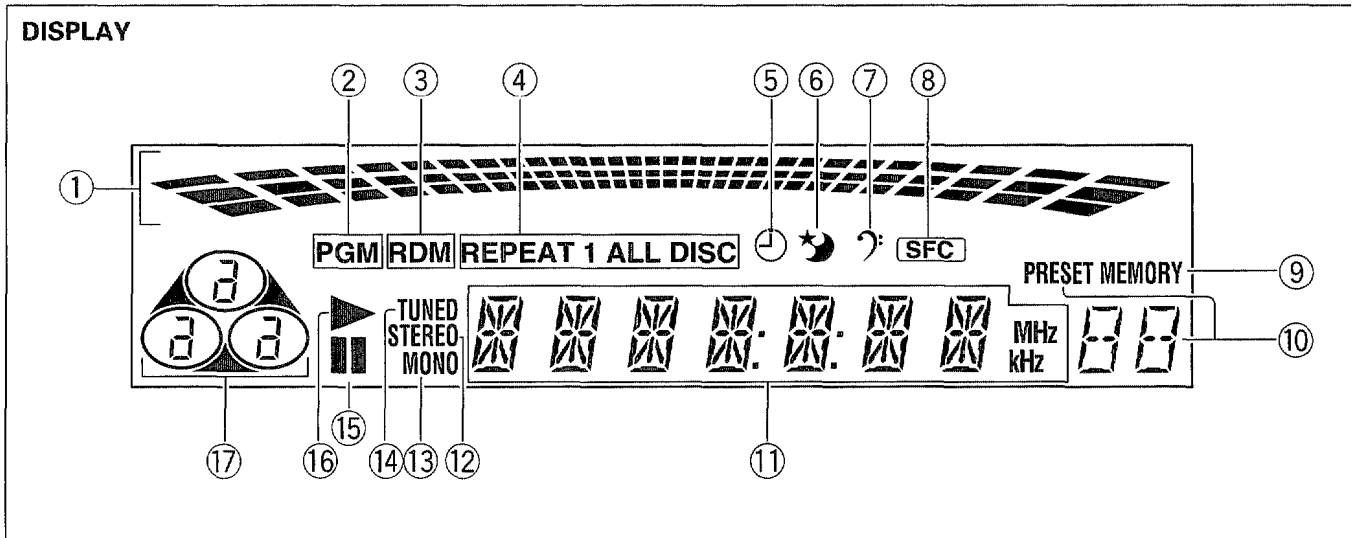

DISPLAY

① Multi meter

Provides a visual display of signal level, volume level or other operation conditions.

② PGM (PROGRAM) indicator

Lights during the program mode.

③ RDM (RANDOM) indicator

Lights during random playback mode.

④ REPEAT indicators

REPEAT 1 : Lights during "repeat-1" playback mode.

REPEAT DISC : Lights when using repeat playback for a single disc.

REPEAT ALL DISC : Lights during "repeat all discs" playback mode.

⑤ TIMER indicator

Lights when the timer is set.

⑥ SLEEP TIMER indicator

Lights when the sleep timer is set.

⑦ P.BASS indicator

Lights when the P.BASS function is ON.

⑧ SFC (Sound Field Control) indicator

Lights when the SFC function is ON.

⑨ MEMORY indicator

Lights when the MEMORY button is pressed during manual preset operation.

⑩ Preset number display

When manual preset operation is used, the preset station number is displayed here.

⑪ Displays broadcast reception frequencies and other main operating conditions.

⑫ STEREO indicator

Lights during reception of a stereo broadcast.

⑬ MONO indicator

Lights when receiving a broadcast program in monaural.

⑭ TUNED indicator

Lights to indicate reception of a broadcast frequency.

⑮ Pause indicator (||)

Lights during pause mode.

⑯ Play indicator (▶)

Lights when playing a CD.

⑰ Disc tray number indicator

Lights when the function is set to CD. The currently playing disc number flashes.

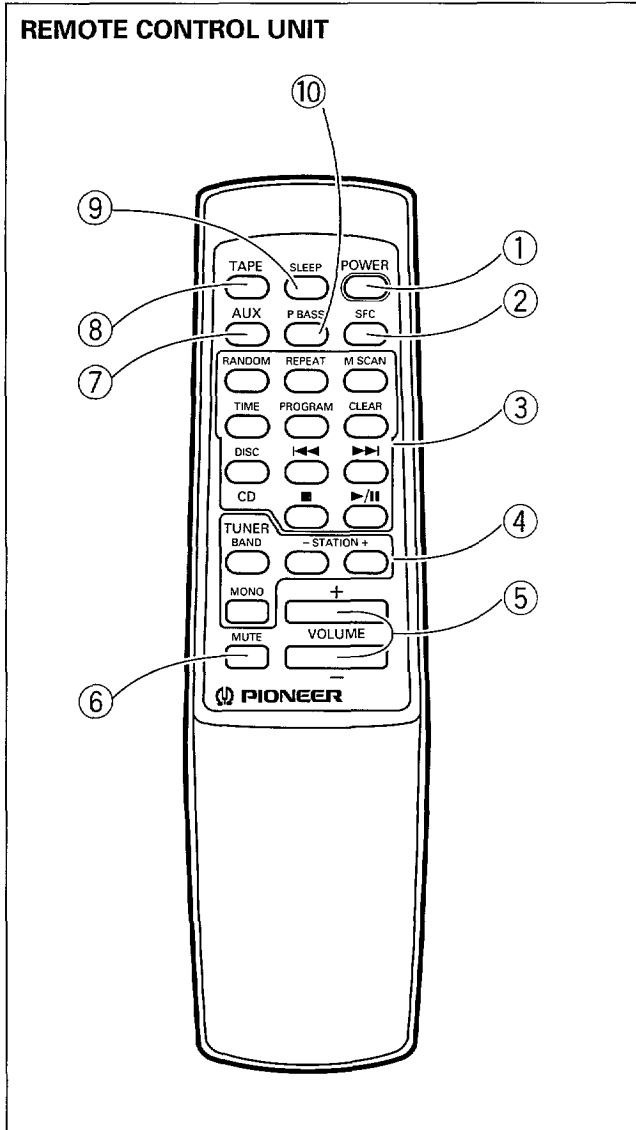

REMOTE CONTROL UNIT

① **POWER button**

② **SFC (Sound Field Control) button** P.23

Each time this button is pressed, the mode changes in the following sequence:

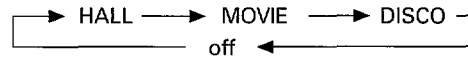

③ **CD operation buttons**

RANDOM : Random playback P.18

REPEAT : Repeat playback P.18

M.SCAN : Music (Intro) Scan P.18

TIME : Select time display mode. P.17

PROGRAM : Set to track programming mode. P.19

CLEAR : Use to erase the track program. P.19

DISC : Disc No. selection P.17

◀◀ : Manual/Track search (reverse)

▶▶ : Manual/Track search (forward)

■ : Stop

▶/|| : Play/Pause

Each time this button is pressed, the mode changes between playback and pause.

④ **TUNER operation buttons**

STATION -/+ (down/up) buttons P.14

Before operation, memorize broadcast stations with the STATION CALL buttons.

+ Stations change in order in the upward direction.

- Stations change in order in the downward direction.

MONO button P.13

During reception of FM stereo broadcasts, use to switch between stereo and monaural reception.

BAND button P.13

Use to switch between FM and AM bands.

⑤ **VOLUME +/- buttons**

Increases/decreases the sound volume of the unit.

⑥ **MUTE button**

Press to temporarily minimize sound volume. Press again (or use the VOLUME button) to restore sound to its original volume.

⑦ **AUX function button**

⑧ **TAPE function button**

⑨ **SLEEP button** P.25

Each time this button is pressed, the setting changes in the following sequence:

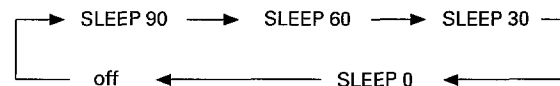

⑩ **P.BASS button** P.23

SETTING THE CLOCK

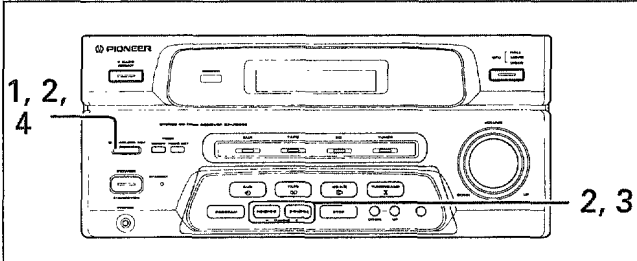

- When the power plug is first connected, the unit automatically enters the demo (demonstration) display mode. Press the P.BASS (DEMO) button to cancel the demo mode, then set the clock display to the current time.
- Set the clock when it has been incorrectly set, or when power has been cut to the unit.
- This clock provides a 24 hour display.
- The clock cannot be set by the remote control unit.

Example: Setting the clock to 6:40.



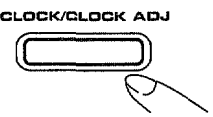

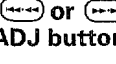
1. While power is turned off, keep the CLOCK/CLOCK ADJ button pressed for more than 3 seconds.

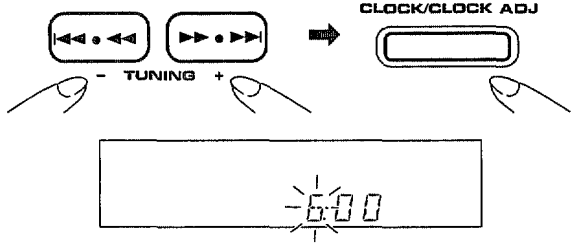

2. Set the hour by quickly pressing and releasing the  or  button, then press the CLOCK/CLOCK ADJ button.



3. Set the minutes by quickly pressing and releasing the  or  button.

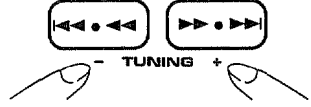

4. Press the CLOCK/CLOCK ADJ button, when "00" seconds of that minute are reached for precise adjustment.

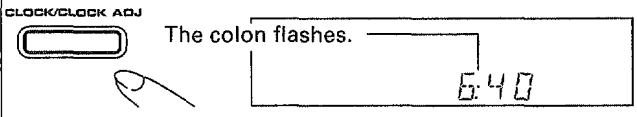

- To check the time during playback, press the CLOCK/CLOCK ADJ button. The current time will be displayed for about three seconds.
- After connecting to an AC outlet, be sure to set the present time. Timer playback is not possible unless the time has been set.
- The time display will appear as "--:--" when the power is restored following a power failure, or if the power cord has been disconnected. In this case, be sure to set the present time again.

12

<AZR7047>

TURNING ON THE POWER

Operations indicated by the  mark are performed with the remote control unit.

- Confirm the speakers and antenna connections by reading section "CONNECTIONS" again.
- When the power plug is connected into AC wall outlet, the unit enters the demonstration mode. Press the P.BASS (DEMO) button to cancel the demonstration mode.

1. Press the POWER switch (or POWER button on the remote control unit).

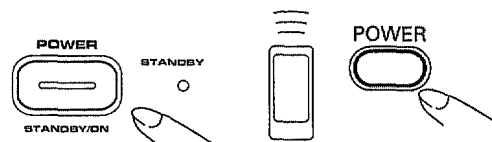



To switch the power OFF:

Press the POWER switch again.

The clock display reappears and STANDBY indicator lights.

Direct power on

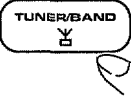
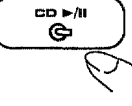
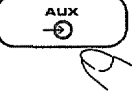
- When set to the OFF (STANDBY) position, the following operations will turn on the power.

1		2	
3		4	

1. Pressing the TUNER/BAND button:

AM or FM radio broadcast will be received.

2. Pressing the CD (▶/||) button:

If a CD is loaded, playback will begin.

3. Pressing the AUX button:

If the component connected to the AUX jacks is operating, sound will be output.

4. Pressing the TAPE button:

If you press the TAPE button, power switches ON.

TUNING INTO STATIONS

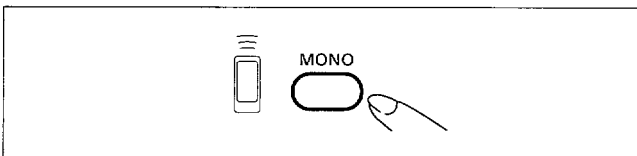
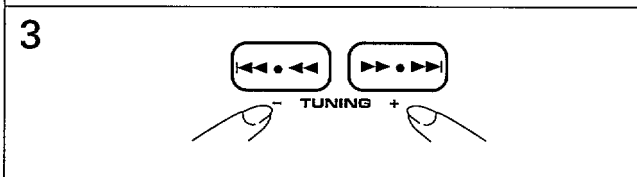
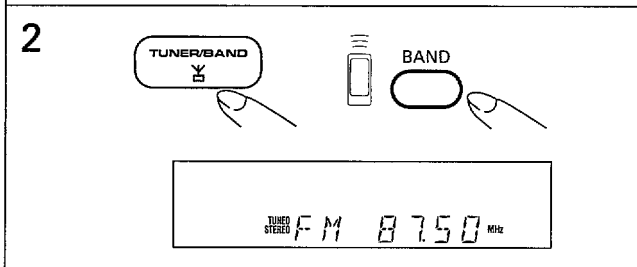
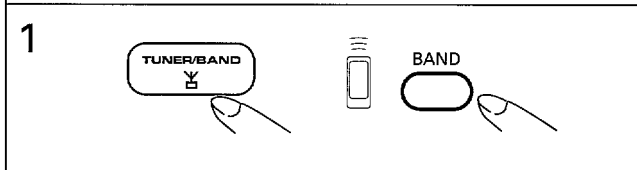
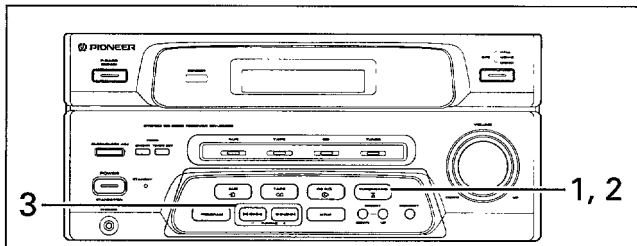

- Do not place the AM antenna on a metallic case including the receiver cabinet or near a CD player, LD player, DAT recorder, personal computer or TV set. Any of these installations will cause noise in reception.
- Broadcast reception is not possible unless an antenna is connected, so be sure to connect one.

1. Press the **TUNER/BAND** button.
2. Select the radio band with the **TUNER/BAND** button.
"AM" or "FM" indicator will light on the display.
3. Press the **◀◀◀** or **▶▶▶** button for lower or higher frequencies.

[Manual tuning]

Press the **◀◀◀** or **▶▶▶** button and release quickly. The tuning frequency will change by one step each time the button is pressed. Press as many times as necessary to tune in the desired station. The TUNED indicator lights up when the station is tuned in best.

[Auto tuning]

Press the **◀◀◀** or **▶▶▶** button until the frequency starts to change, then release it. The tuner automatically search for a broadcasting station, stops when one is found and the TUNED indicator lights up. To search for another station, press again.

- To interrupt auto tuning, press the **◀◀◀** or **▶▶▶** button again.

[High-speed manual tuning]

Press and hold the **◀◀◀** or **▶▶▶** button.
→The frequency varies continuously and stops when your finger is removed from the button.

MONO button (on the remote control unit)

During FM reception: Switches between stereo and monaural modes when listening to a stereo broadcast. If there is a lot of noise in the stereo position, switch to MONO and the noise will be suppressed. MONO indicator will light on the display.

Last station memory

The last received AM and FM stations remain stored regardless of function and/or POWER switching. The last memory function will be canceled if the power cord is disconnected or if a power failure occurs.

MEMORIZING STATIONS

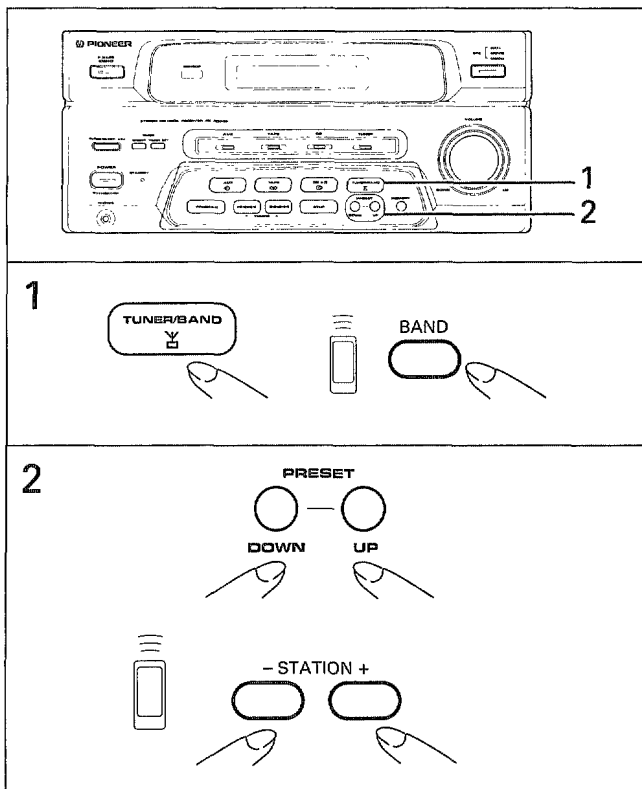
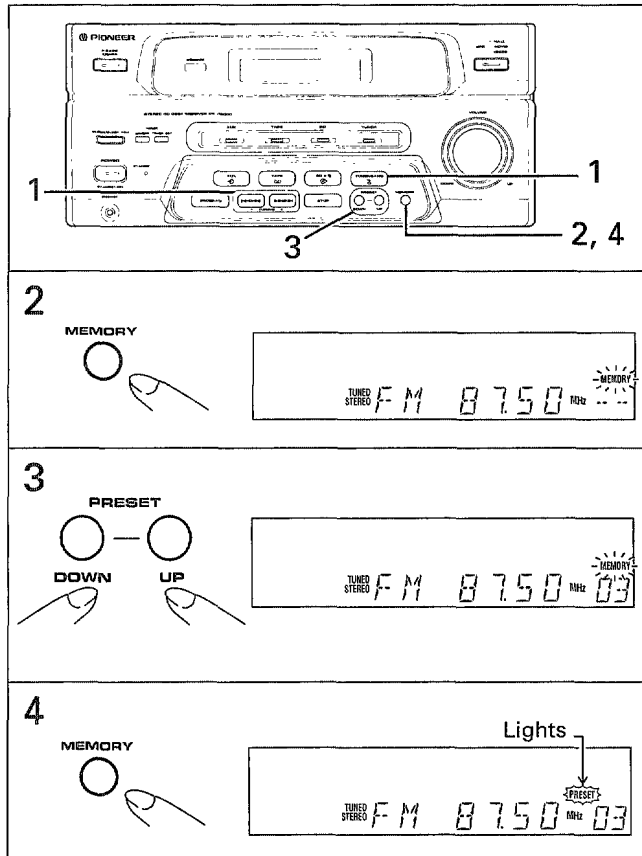

Manual presetting

- Up to 30 FM/AM stations can be memorized at random.
- For FM reception, the MONO setting can be memorized.

Example: To memorize FM 87.5 MHz as preset station 3.

1. Tune in the desired station.
2. Press the MEMORY button.
Operate while the display (MEMORY) is flashing.
3. Select the station number to be memorized by pressing the PRESET (DOWN or UP) button within 10 seconds.
4. Press the MEMORY button.
Operate while the display (PRESET) is lit.

The displayed frequency is stored in the selected Station. Repeat steps 1 through 4 to memorize up to 30 stations.

Station call

1. Press the TUNER/BAND button.
2. Press the PRESET (DOWN or UP) button to select the desired station.

NOTES:

- The memorized stations will not be erased even if the power is turned off. However, if the AC power cord is unplugged or a power failure occurs, the memorized stations will be erased (if the AC power cord is unplugged, the memorized stations will be retained for several days).
- If the memorized stations have been erased, memorize them again.

CAUTIONS REGARDING COMPACT DISC HANDLING

CARE OF DISCS

- When holding discs, do not touch their signal surfaces.
- Never rub the disc surface with force.

STORING DISCS

- Always store discs in their cases vertically, avoiding locations with high heat or humidity, or extremely low temperatures.
- Always read and abide by the precautionary notes listed on the disc labels.

CLEANING DISCS

- Fingerprints or smudges on the surface of a disc will not directly affect the recorded signals. Always keep your discs clean by wiping them gently with a soft cloth from the inner edge toward the outer periphery.
- If a disc becomes very dirty, dip a soft cloth in water, and after wringing it out well, wipe the dirt away gently. Remove any water drops with another soft, dry cloth.
- Do not use record cleaning sprays or anti-static agents on discs. Never clean discs with benzene, thinner, or other volatile solvents, since damage to the disc surface may result.

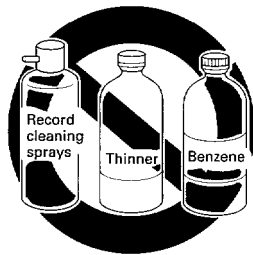
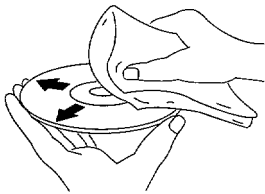

- Do not affix gummed labels or tape to the label surfaces. Also, do not scratch or damage the disc.
- Discs rotate at high speed inside the player. Do not use damaged (cracked or warped) discs.

CD LENS CLEANER

The player's pickup lens should not become dirty in normal use, but if for some reason it should malfunction due to soiling, consult your nearest PIONEER authorized service center. Lens cleaners for CD players are commercially available, but special care should be exercised in their use since some may cause damage to the lens.

HOW TO HANDLE CASSETTE TAPES

Is the tape loose, or is some of the tape sticking out of the cassette?

This will damage the tape itself. To remove the slack, insert a pencil into the spool and gently wind it.

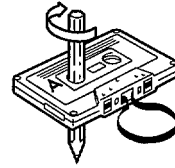

Safekeeping

Put the cassette tape back into its case and store it in a location not exposed to magnetic field, humidity, dust or oil.

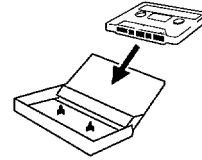

TIPS ON USING CASSETTE TAPES

- Leader tape (which does not allow sound to be recorded over it) is provided at the beginning of a cassette tape. Start recording after allowing the tape to run for approx. 5 seconds so that the leader tape clears the recording head.
- Forwarding or reversing the cassette tapes before recording prevents damage to the unit caused by tape slack.

Do not use tapes longer than 90 minutes.

Since tapes longer than 90 minutes are so thin, they easily jam in the pinch roller and capstan, and they are susceptible to other trouble such as irregular winding. Try not to use them with this unit.

How can you prevent accidental erasure?

When the tab on the cassette shell is broken out with the tip of a screwdriver, it will not be possible to activate the recording function even by pressing the ● button, so valuable recordings will not be erased in error.

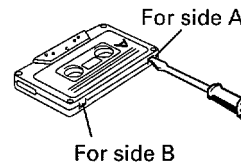

With TYPE I (Normal) tapes, when you want to record again on a cassette with broken erasure prevention tabs, cover the hole with a double layer of adhesive tape.

Use only TYPE I (Normal) tapes with this unit; TYPE II (HIGH/CrO₂) and TYPE IV (Metal) tapes cannot be used.

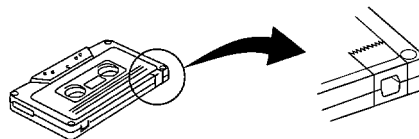

LISTENING TO COMPACT DISCS

1

2, 3

4

The number of the currently playing disc will flash.

To play a compact disc

1. Press the CD (▶/||) button.
2. Press the OPEN/CLOSE (▲) button and load disc with their label surfaces facing up.

- The disc number is printed on the tray. Press the DISC SKIP button to rotate the tray, then place the disc on the tray.
- Even when only one disc is loaded, the unit automatically rotates the tray (regardless of which disc number), and detects the disc position to begin playback.

3. Press the OPEN/CLOSE (▲) button to close the tray

4. Press the CD (▶/||) button.

The tray will rotate 120° clockwise and playback of DISC 1 will begin. ① flashes to indicate the playback of DISC 1, and the display shows the current track number and its elapsed playing time. (The trays are indicated as "disc ①", "disc ②" and "disc ③".)

When all the discs and tracks have been played, the CD player stops.

NOTES:

- The number of the currently playing disc is indicated by the flashing numeral on the display.
- Even during playback, pressing the OPEN/CLOSE (▲) button will cause the tray to open. Likewise, the DISC SKIP button can be pressed when the tray is open to change the currently selected disc.

To stop playback

Function	Buttons
To stop playback	
To stop playback temporarily	
To play back again	

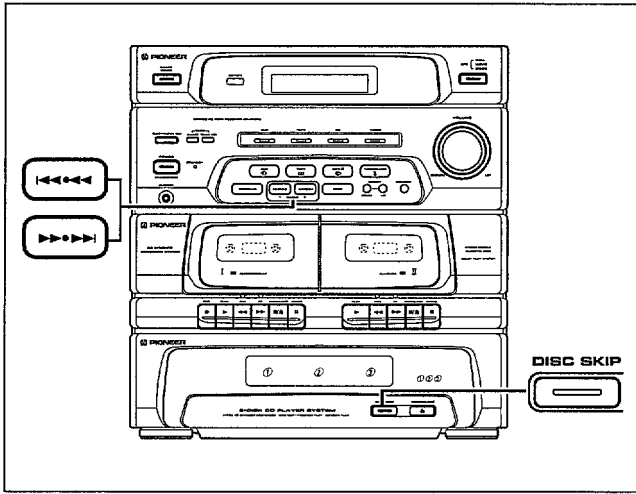

To search for a particular track

Function	Buttons
To search for the beginning of a track	<p>Press and release.</p>
To rapidly advance forward or backward	<p>Press and hold.</p>

Precautions during programmed play :

- Track search is performed only on those tracks which have been programmed.
- Manual search can be performed only on the track currently playing.

Time display

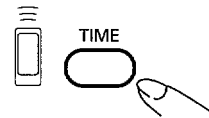

During playback, pressing the TIME button on the remote control unit changes the time display in the following sequence:

- Ⓐ Number and elapsed time of currently playing track.
- ↓
- Ⓑ Number and remaining time of currently playing track.
- ↓
- Ⓒ Remaining time of currently playing disc.
- ↓
- Return to Ⓐ again

NOTE:

The above display Ⓒ does not appear during programmed play or random play.

Selecting a different disc during play



Play will begin from the beginning of the next disc.

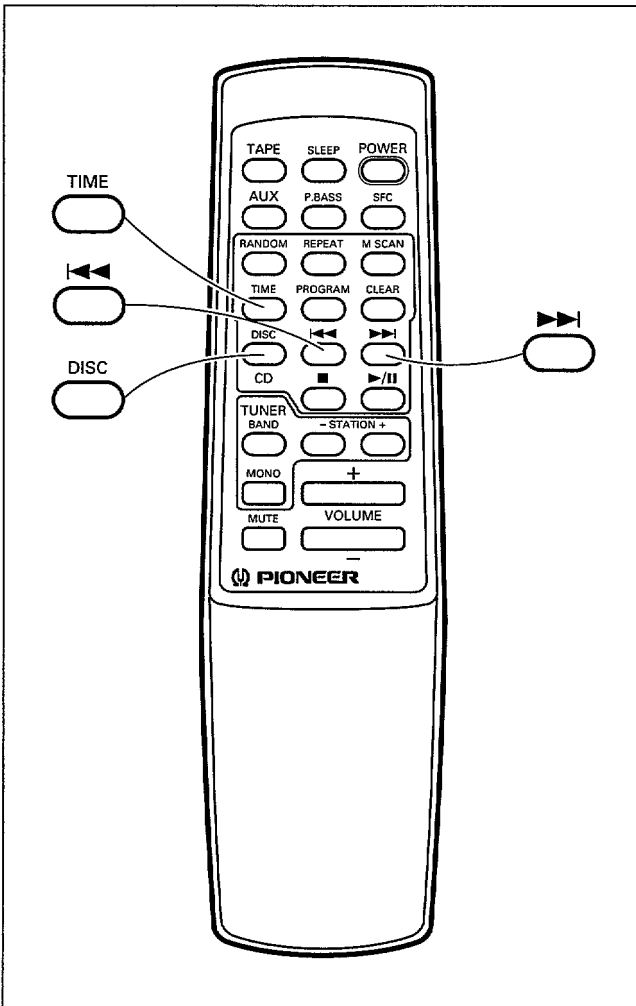

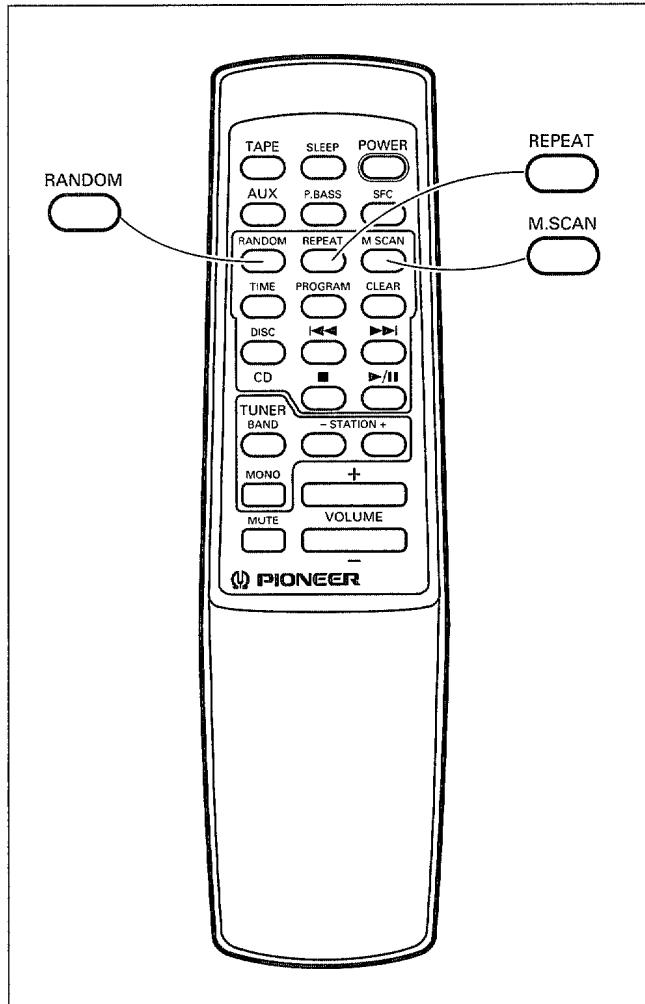

Music (Intro) scan

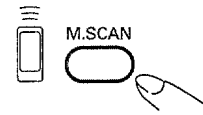

Press during play, or when the disc is stopped. The first ten seconds of each track will be played in order. When you hear a track you wish to listen to, press the button on again to stop the scan and resume normal play at that track. During M.SCAN operation, the track number flashes on the display.

Random playback - To play all tracks in random order



When the remote control unit's RANDOM button is pressed during playback or stop mode, all the tracks of the three CDs will be randomly played. (RDM will appear on the display).

- To exit random mode, press the RANDOM button.

NOTES:

- During play you can use ►► to select another random track or ◀◀ to play the same track again.
- One randomly selected track from each disc will be played in the order of the discs loaded.

Example: When three CDs are loaded, the following sequence will be repeated.

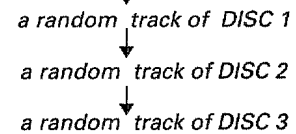

After all tracks on all three discs are played, the player will stop.

To repeat playback (repeat play)



During play, pressing the REPEAT button on the remote control unit changes the repeat function in the following sequence:

- Ⓐ Repeat of the currently playing track (REPEAT-1).
- ↓
- Ⓑ Repeat entire currently playing disc (REPEAT DISC).
- ↓
- Ⓒ Repeat play of all discs loaded (REPEAT ALL DISC).
- ↓
- Repeat function OFF

During random playback and programmed playback, the function changes in the order REPEAT-1 → REPEAT DISC → REPEAT ALL DISC → OFF.

In the case of random play and programmed play, the repeat functions operate as follows:

- REPEAT-1 : Currently playing track is repeated.
- REPEAT DISC : The currently playing disc is played repeatedly in random or programmed order.
- REPEAT ALL DISC : Repeat random or repeat programmed play is performed for all discs.

TO PLAY ONLY DESIRED TRACKS ON A CD

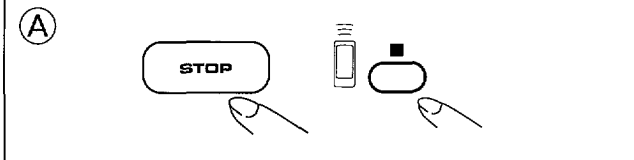
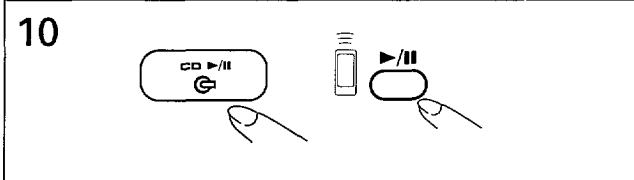
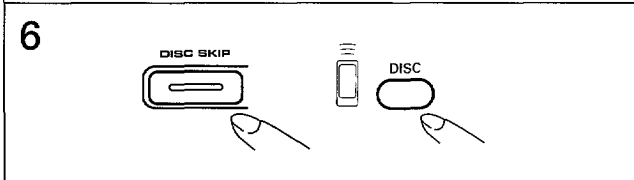
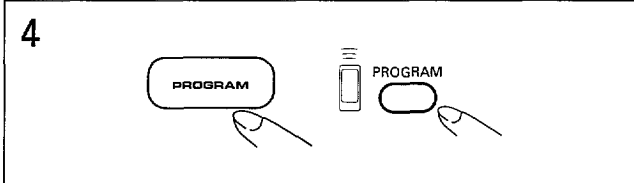
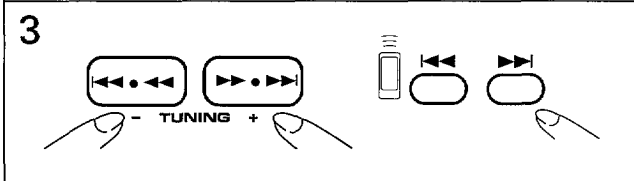
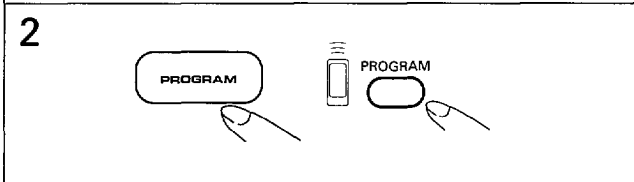
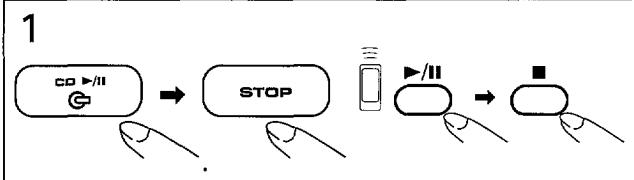
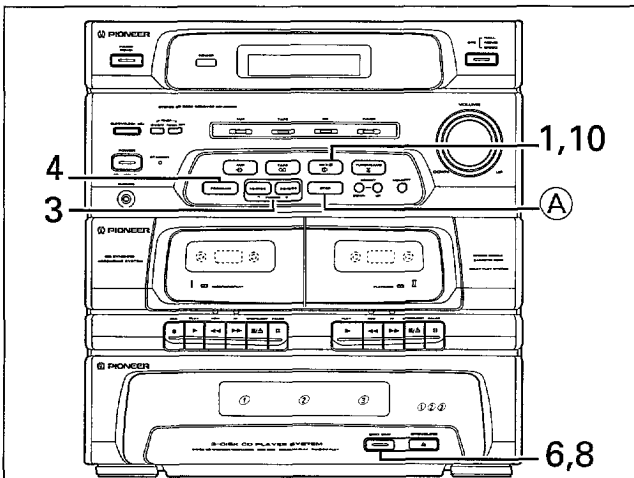

Programmed playback - To program tracks in desired order

Set the first disc to be programmed in disc tray position ①.

1. Press the CD (▶/II) button, then press the Stop (■) button.
2. Press the PROGRAM button.
DISC ① flashes, and the display will show "PGM" and "0-----".
3. Press the ◀◀ or ▶▶ button.
(Press within 10 seconds after pressing the PROGRAM button.)
So that the desired track number appears on the display.
4. Press the PROGRAM button.
5. Repeat steps 3 and 4, to program all desired tracks from DISC 1.
Up to 32 steps can be programmed.
If you exceed the maximum of 32 tracks, "FULL" will appear in the display.

6. Press the DISC SKIP button.
DISC 1 will move to the play position but playback will not start.
DISC ② flashes. Set the second disc in the tray position marked ②, and set the third disc in tray position marked ③.
7. Repeat the same steps as for DISC 1 to program DISC 2.
8. After programming tracks from DISC 2, press the DISC SKIP button again.
The tray will not rotate, but the DISC ③ indication will begin to flash.
9. Program DISC 3 in the same way as for DISC 1 and DISC 2.
10. Press the CD (▶/II) button.
Play starts with the first track of the program.

A To stop Programmed playback, press the Stop (■) button.

"PGM" disappears on the display but the program still remains in the memory. To start programmed playback again, press the PROGRAM button ("PGM" appears on the display), then press the CD (▶/II) button to start.

To clear all of the programmed contents

Perform either of the following procedures ① or ②.

- ① In the stop mode, press the Stop (■) button at about 3 seconds.
- ② In the stop mode, each time the CLEAR button on the remote control unit is pressed, the last programmed step will be cleared.

TO PLAY ONLY DESIRED TRACKS ON A CD

Designating Disc Numbers for Programmed Play

As shown in the illustration, each of the trays is marked with a disc number. No matter in what order the discs are placed in the tray, the designation of Disc 1, Disc 2 and Disc 3 is performed automatically.

Use the DISC SKIP button (or the DISC button on the remote control unit) to select the disc you wish to play.

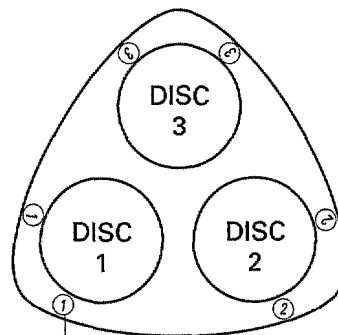

(Disc numbers are printed on tray).

PLAYING TAPES

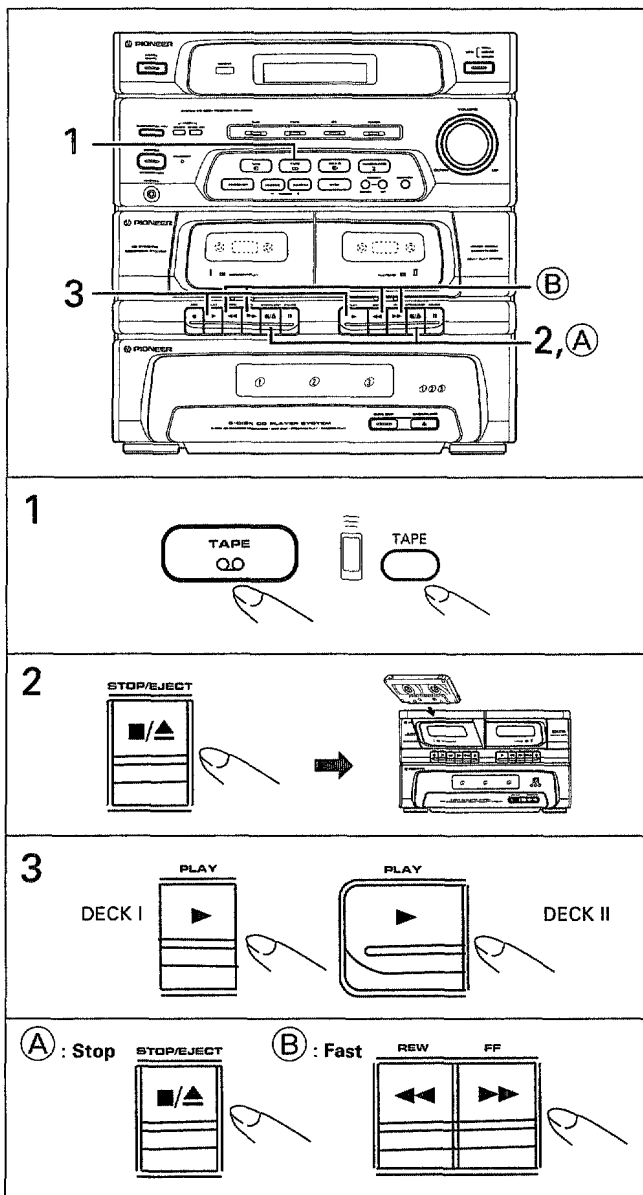

Basic operation

Use only TYPE I (Normal) tapes for playback. TYPE II (HIGH/CrO₂) tapes and TYPE IV (Metal) tapes can played back, although the sound may change somewhat.

●Tapes may be played back in Deck I or Deck II but not in both decks at the same time.

1. Press the TAPE button.
2. Press the Stop/Eject (■/▲) button and load a record tape, then push in the cassette door until it locks.
3. Press the Play (▶) button to start playback.

Ⓐ To stop playback, press the Stop/Eject (■/▲) button.

Ⓑ To fast forward or rewind, press the fast forward (▶▶) button or rewind (◀◀) button.

NOTE:

If the power is switched off while the tape is running, you will not be able to open the door. In this case, switch on the power again and press the Stop/Eject (■/▲) button once more.

Auto Stop Mechanism

This mechanism automatically stops the tape when the end of the tape is reached during fast forward (▶▶) or rewind (◀◀).

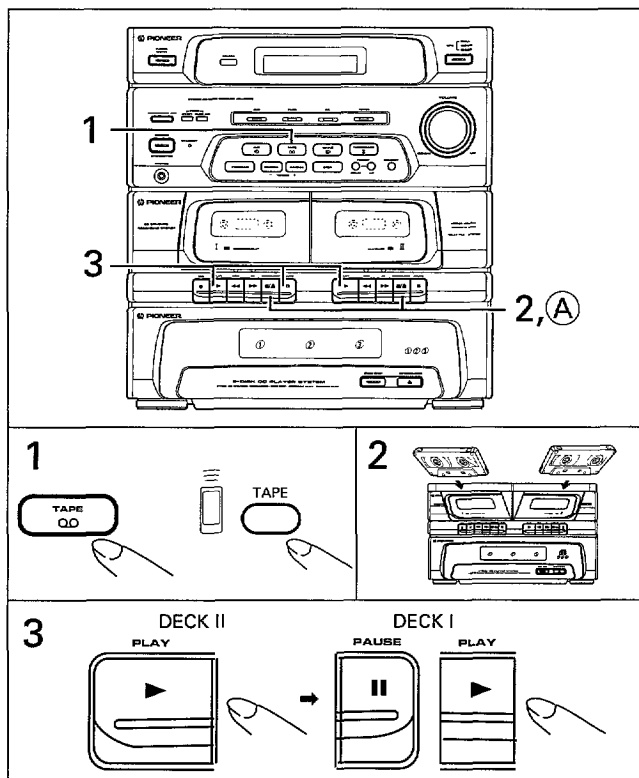

Continuous playback of two cassettes

Continuous playback begins from DECK II and continues on DECK I.

1. Press the **TAPE** button.
2. Load a recorded tape in Deck II and Deck I.
3. First press the **Play** (▶) button on Deck II, on Deck I press the **Pause** (||) button followed by the **Play** (▶) button.
Playback begins with DECK II.
Playback stops when the tape in DECK II reaches the end.
The Pause button will be automatically released and playback continues with DECK I.

A To stop playback, press the **Stop/Eject** (■/▲) button.

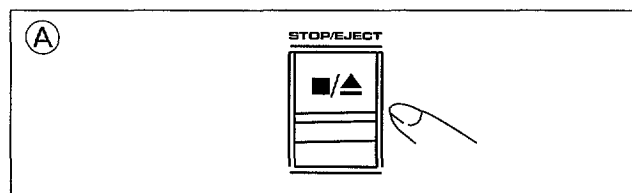

RECORDING

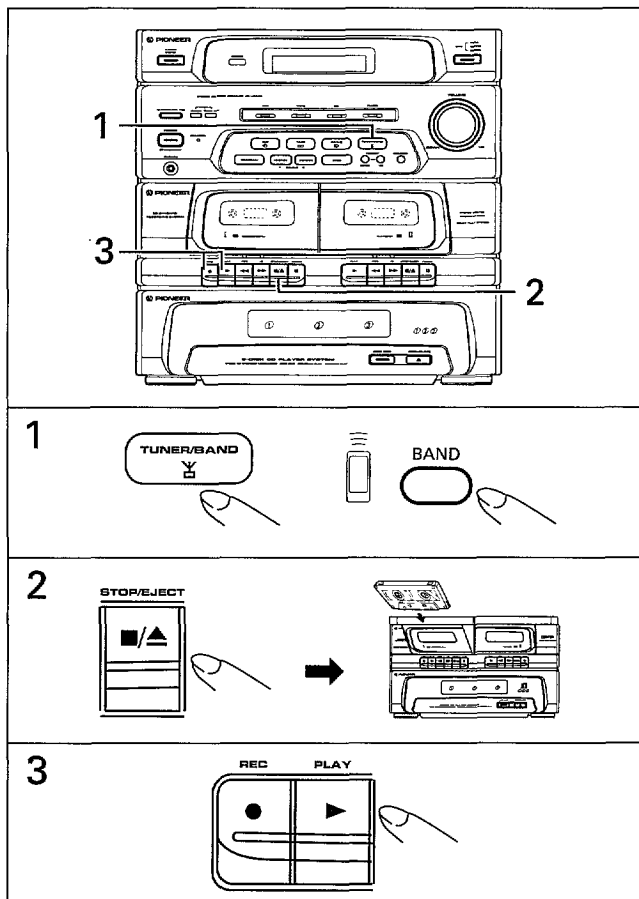

Recording a radio broadcast onto a cassette tape

Use only **TYPE I (Normal)** tapes for recording. **TYPE II (HIGH/CrO₂)** tapes and **TYPE IV (Metal)** tapes cannot be used.

- Material can be recorded on Deck I only. Recording is not possible on Deck II.
- Recording is possible only in the forward (▶) direction. After you have completed recording one side of the tape in the forward (▶) direction, take out the tape, turn it over and reinsert it to record on the other side.
- See [P.22](#) for special details regarding how to record Compact Discs onto cassette tape.

1. Press the **TUNER/BAND** button to receive the broadcast.
2. Load the tape for recording into Deck I.
3. Press the **Rec** (●) button and **Play** (▶) button simultaneously to start the recording; when the tape reaches its end, the tape stops.

(In step 1, if the **AUX** button is pressed instead of the **TUNER/BAND** button, recording will be performed from the component connected to the **AUX** input jacks.)

NOTES:

- To interrupt recording, press the **Pause** (||) button.
To continue recording, press the **Pause** (||) button again.
- Press the **Stop/Eject** (■/▲) button if you want to stop the recording before the end of the tape.
- If you press the **Rec** (●) button only, the **Play** (▶) button will be pressed automatically.
- The contents of a tape can be erased by pressing the **Rec** (●) button when the function selector is set to **TAPE**.

RECORDING

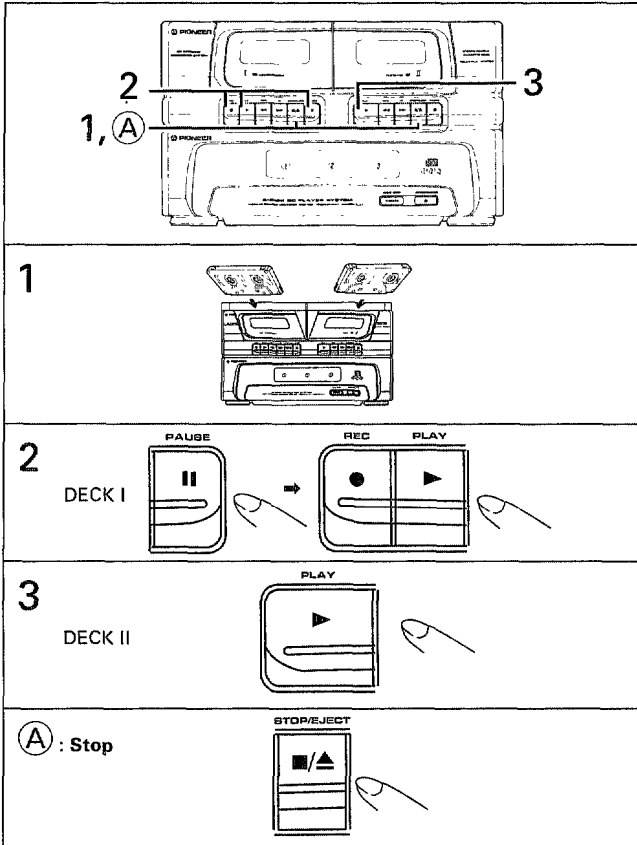

Copying a tape

Use only TYPE I (Normal) tapes for recording.

TYPE II (HIGH/CrO₂) tapes and TYPE IV (Metal) tapes cannot be used.

While copying a tape, you can listen to another sound source you want, so it is not necessary to place the unit in TAPE mode.

1. Load the recorded tape into Deck II and the tape for recording into Deck I.

- Wind the tape forward past the leader to the start of the magnetic coated portion.

2. Press the Pause (||) button on Deck I, then press the Rec (●) and the Play (▶) buttons simultaneously.

3. Press the Play (▶) button on Deck II to start the copying.

NOTES:

- The Pause (||) button on Deck I will automatically be released.
- When the tapes reach the end, copying stops.
- The Rec (●) and Play (▶) buttons will automatically be released.
- If you want to copy the other side of the tape, flip both tapes over to continue copying.

A To stop the copying, press the Stop/Eject (■/▲) button on both decks.

Recording a CD onto a cassette tape

Use only TYPE I (Normal) tapes for recording.

TYPE II (HIGH/CrO₂) tapes and TYPE IV (Metal) tapes cannot be used.

1. Press the CD (▶/||) button.

If a disc is loaded in the tray, press the Stop (■) button at step 1.

2. Press the OPEN/CLOSE (▲) button to open the tray. Insert a disc into the tray.

Press the DISC SKIP button and select the number of the disc you wish to record. [P.20]

3. Press the OPEN/CLOSE (▲) button to close the tray.

4. Press the CD (▶/||) button two times to set the player to the pause condition.

5. Load the tape for recording into Deck I.

6. Press the Rec (●) and Play (▶) buttons simultaneously to start recording.

NOTE:

When recording a CD onto tape, be sure to follow the above steps 1-6.

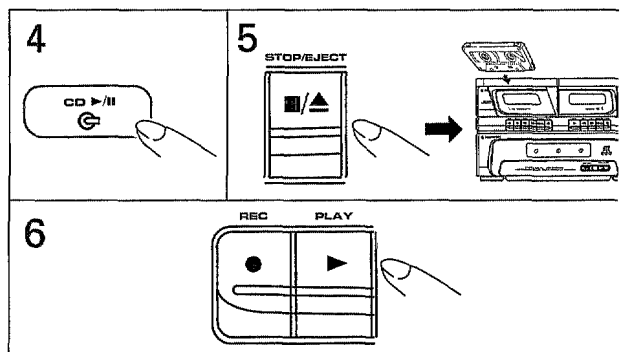
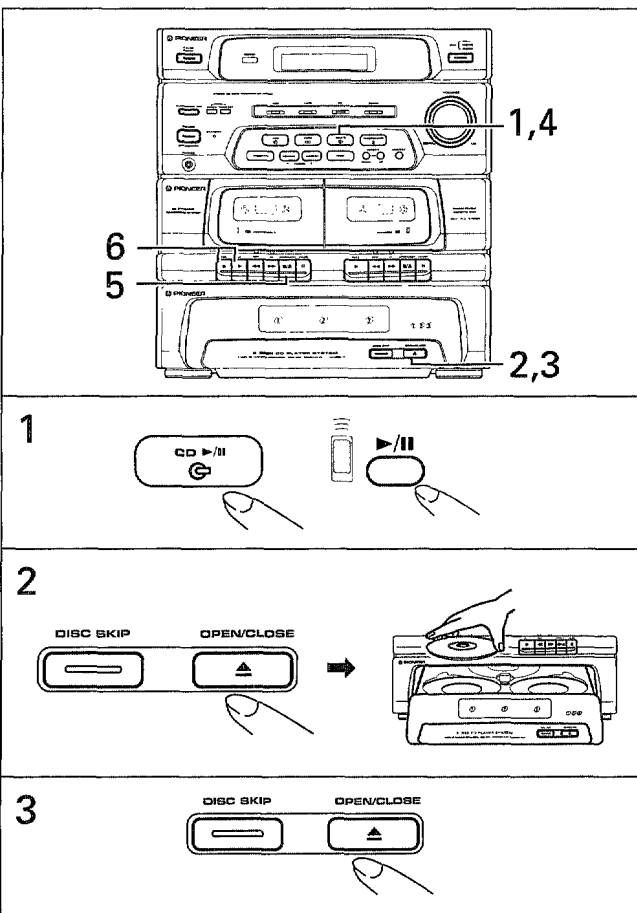

SOUND FIELD CONTROL OPERATION (SFC)

Selecting a preset sound setting

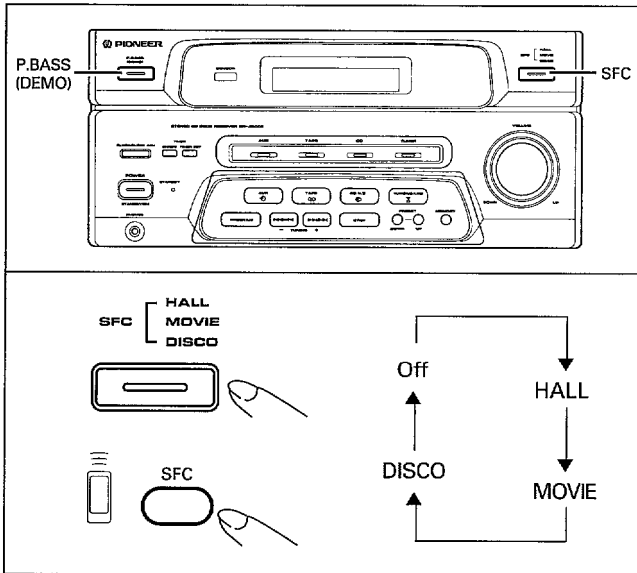

Select one of the three settings with the SFC button.

- HALL :** Provides a reverberation effect like that produced in a concert hall.
- MOVIE :** Naturally reproduces the conversations and effect sound, and provides wide and dynamic acoustics. This is effective with movie software.
- DISCO :** This boosts bass to deliver a powerful, more dynamic sound.

To clear SOUND FIELD CONTROL settings:

Press the SFC button until OFF is selected.

NOTE:

The P.BASS function is canceled when SOUND FIELD CONTROL is selected.

ADJUSTING THE SOUND

Boosting the bass sound

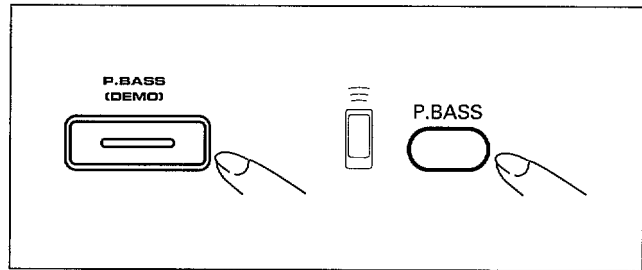

Press the P.BASS (DEMO) button to produce a powerfully enhanced bass sound.

- Press the button once more to return to normal sound.

NOTE:

SOUND FIELD CONTROL is canceled when P.BASS function is selected.

TIMER PLAYBACK

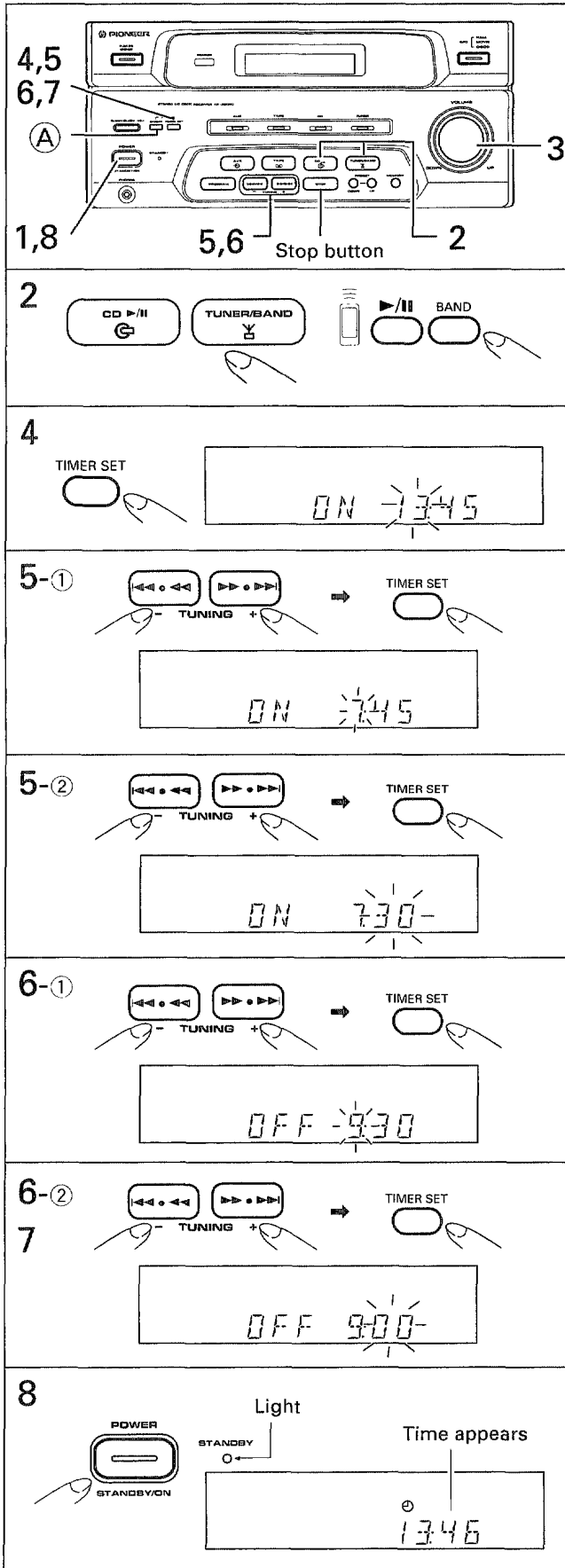

Setting the WAKE-UP timer

Example: Using the TIMER from 7:30 to 9:00

- 1. Switch the power ON.**
- 2. Select the input function to be played to wake you up.**
 CD: Load the CD.
 Tuner: Select the station.
 If the CD function is selected on the main unit, it is played immediately so you also have to press the Stop button (■) to stop it. (Only if a CD is currently loaded.)
- 3. Set the volume to the desired level.**
- 4. Press the TIMER SET button.**
- 5. Set the timer start time.**

- ① Set the hour.
Set the hour using the (◀◀◀) or (▶▶▶) button, and then press the TIMER SET button.
- ② Set the number of minutes.
Set the number of minutes using the (◀◀◀) or (▶▶▶) button and then press the TIMER SET button.

6. Set the timer finish time.

- ① Set the hour.
Set the hour using the (◀◀◀) or (▶▶▶) button, and then press the TIMER SET button.
- ② Set the number of minutes.
Set the number of minutes using the (◀◀◀) or (▶▶▶) button.

7. Press the TIMER SET button, and the set time automatically confirmed.

After a few seconds confirmation is completed, and the display returns to the original indications (the timer operates at the set time).

The time indicator (⌚) lights on the display.

8. Turn the power off.

The system enters the STANDBY mode.

Set up is complete.

- Ⓐ **To cancel the timer :** Press the TIMER ON/OFF button to turn the timer off; the time indicator (⌚) will disappear.

To confirm timer settings: With the power turned on, press the TIMER SET button. About ten seconds afterwards, the unit enters the check mode, and the display will automatically show the following items in the order noted:

CHECK → Name of Input Function, Volume Level -
 Normal display ← OFF time ← ON time ←

NOTES:

- The wake-up timer works every day at the same hour, unless it is reset or canceled.
- When the sleep timer is set during wake-up timer operation, the sleep timer has priority.
- The timer is canceled when the TIMER SET button is pressed during its operation.

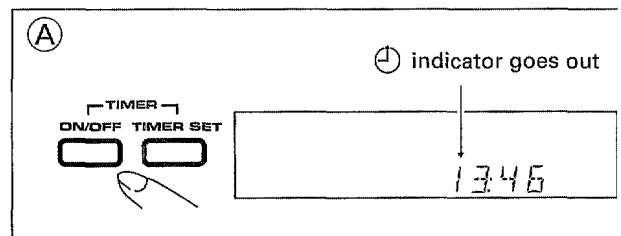

SLEEP TIMER

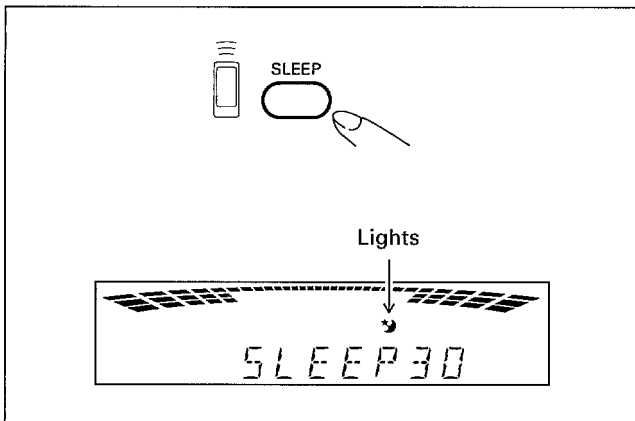

Sleep timer - Automatically turns off the power

Power turns off automatically after the specified time has elapsed. Each time the SLEEP button is pressed, the setting changes in the following sequence:

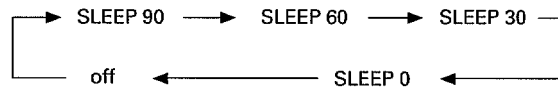

NOTES:

- After the sleep timer is set, you can display the remaining time (the time decrements automatically) by pressing the SLEEP button once; if the button is then pressed again, the set time will change as described above.
- If the unit is left with the "0" displayed, the sleep function will turn off in about two seconds and the display will return to normal.
- If both the sleep timer and wake-up timer are set together, the sleep timer will be given priority in operation.

MAINTENANCE

Cleaning the head section

The heads, capstan and pinch roller are parts which are liable to become dirty quite easily. In particular, if the heads are dirty, the high frequency components of the sound will not be reproduced and the stereo balance will be impaired, resulting in a deterioration of sound quality. It is therefore recommended that the head section be cleaned regularly.

1. Turn the power off.
2. Press the Stop/Eject (■/▲) button to open the cassette door.
3. Dip a cleaning swab into some head cleaning fluid and use it to wipe the head, capstan, and pinch rollers. Wait 2-3 minutes until the cleaning fluid dries.

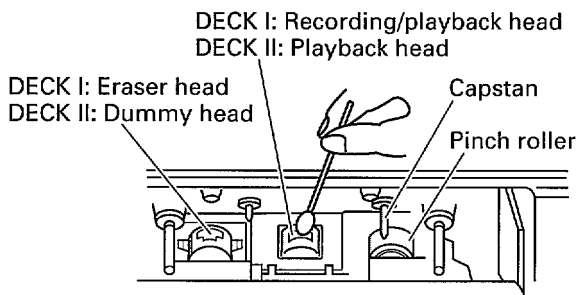

Demagnetizing the cassette deck heads

The deck heads may become magnetized after the deck has been used for a long period of time or if a magnet or other magnetized object (screwdriver, etc.) is brought near the heads. Magnetization of the heads results in increased noise and reduced ability to reproduce high-frequency sounds.

In this case, please use a commercially available head demagnetizer at regular intervals to eliminate the magnetic field on the heads. When using a head demagnetizer, turn this unit's power switch ON. In order to prevent adverse effects on the receiver and speakers, however, **be sure to turn down the receiver's volume control to its lowest position**, and disconnect any headphones from their headphones jack. For details, consult the instructions accompanying your head demagnetizer.

Maintenance of external surfaces

- Use a polishing cloth or dry cloth to wipe off dust and dirt.
- When the surfaces are very dirty, wipe with a soft cloth dipped in some neutral cleanser diluted five or six times with water, and wrung out well, then wipe again with a dry cloth. Do not use furniture wax or cleaners.
- Never use thinners, benzine, insecticide sprays or other chemicals on or near this unit, since these will corrode the surfaces.

TROUBLESHOOTING

Incorrect operations are often mistaken for trouble and malfunctions. If you think that there is something wrong with this component, check the points below. Sometimes the trouble may lie in another component. Investigate the other components and electrical appliances being used.

If the trouble cannot be rectified even after exercising the checks listed below, ask your nearest PIONEER authorized service center or your dealer to carry out repair work.

General

Symptom	Cause	Remedy
There is no power.	<ul style="list-style-type: none"> ● AC cord is unplugged. 	<ul style="list-style-type: none"> ● Plug power cord into a wall socket.
No sound from speakers.	<ul style="list-style-type: none"> ● Volume is turned all the way down. ● Speaker cords are disconnected. ● Speaker cords are connected with the vinyl insulation still on. ● Function is not set to the desired listening source. ● The MUTE button on the remote control unit has been pressed. 	<ul style="list-style-type: none"> ● Raise volume setting. ● Connect speaker cords correctly. P.6 ● Strip vinyl insulation from speaker wire tips before connecting. ● Select correct function. ● Press the MUTE button again.
Sound from only one speaker	<ul style="list-style-type: none"> ● One of the speaker cords is disconnected or damaged. 	<ul style="list-style-type: none"> ● Connect correctly or replace with a new cord.
Strange sounds heard (or recorded) from tape, CD or radio.	<ul style="list-style-type: none"> ● TV is on. ● The unit is too close to the TV. 	<ul style="list-style-type: none"> ● Turn off the TV. ● Move the TV away until interference stops.





Tuner

No AM reception.	<ul style="list-style-type: none"> ● Function is not set to TUNER. ● Loop antenna is not connected. ● Wrong radio band. ● Station is not tuned in. 	<ul style="list-style-type: none"> ● Set to TUNER. ● Connect the loop antenna correctly. P.6 ● Set to the desired radio band. ● Tune in the station.
Beat noise heard.	<ul style="list-style-type: none"> ● TV is on. ● Loop antenna is not positioned properly. 	<ul style="list-style-type: none"> ● Turn off the TV or move the TV away. ● Change the loop antenna position.
Noise heard.	<ul style="list-style-type: none"> ● Interference from nearby fluorescent light, hair dryer, or other electrical appliance. 	<ul style="list-style-type: none"> ● Stop using the device causing the interference.
Sound is distorted.	<ul style="list-style-type: none"> ● Antenna is in a poor position. ● Broadcast is weak. ● Interference from other electrical devices or multipath reception. 	<ul style="list-style-type: none"> ● Change the antenna position. ● Use an external antenna. P.7 ● Change the antenna position.
No stereo sound (during FM broadcasts).	<ul style="list-style-type: none"> ● Function is not set to TUNER. ● Broadcast signal is weak, antenna input is insufficient. ● The MONO button is turned on. 	<ul style="list-style-type: none"> ● Set to TUNER. ● Change to a multi-element external antenna. ● Press the MONO button (on the remote control unit). P.13





CD player

When playback is started, it stops immediately. Pauses or stops during playback.	<ul style="list-style-type: none"> ● Disc is loaded upside down. ● Dirt, etc., on the disc. 	<ul style="list-style-type: none"> ● Load the disc correctly with the label side UP. P.16 ● Clean the dirt from the disc and then play it again. P.15
No sound.	<ul style="list-style-type: none"> ● Function is not set to CD. ● Player is in pause mode. 	<ul style="list-style-type: none"> ● Set to CD. ● Press the CD (▶/) button.
With certain discs, loud noise is produced, or play stops.	<ul style="list-style-type: none"> ● Disc has a bad scratch or warp. ● Disc is extremely dirty. 	<ul style="list-style-type: none"> ● Replace the disc. ● Clean the disc. P.15

Cassette tape deck

Symptom	Cause	Remedy
Cassette door does not open. Cassette door does not close.	<ul style="list-style-type: none"> ● Deck has not stopped. ● Power was switched off while a tape was running. ● Cassette tape is incorrectly loaded. 	<ul style="list-style-type: none"> ● Press the Stop/Eject (■/▲) button. ● Switch on the power again. ● Reload the cassette tape correctly.
Tape does not move.	<ul style="list-style-type: none"> ● Deck is in pause mode. ● Cassette is inserted incorrectly. 	<ul style="list-style-type: none"> ● Press the Pause () button. ● Put the cassette in the holder properly.
No sound heard from tape.	<ul style="list-style-type: none"> ● Function is not set to TAPE. ● Playing an unrecorded tape. 	<ul style="list-style-type: none"> ● Set to TAPE. ● Play a recorded tape.
Cannot record.	<ul style="list-style-type: none"> ● Erasure prevention tabs are broken off. ● Dirty head. 	<ul style="list-style-type: none"> ● Apply adhesive tape over the tab holes. ● Clean the head.  P.25
Previously recorded sounds remain.	<ul style="list-style-type: none"> ● Dirty head. 	<ul style="list-style-type: none"> ● Clean the head.  P.25
Cannot copy tape.	<ul style="list-style-type: none"> ● One deck has no tape loaded. ● Tape in Deck I has erasure prevention tabs broken off. 	<ul style="list-style-type: none"> ● Load tapes in both decks. ● Use a cassette that can be recorded on, or apply adhesive tape over the tab holes.  P.15
Sound is muffled and unclear.	<ul style="list-style-type: none"> ● Dirty head. 	<ul style="list-style-type: none"> ● Clean the head.  P.25
High-range sounds are over-emphasized.	<ul style="list-style-type: none"> ● The cassette tape used is a TYPE II (HIGH/CrO₂) or TYPE IV (Metal) tapes. 	<ul style="list-style-type: none"> ● Use only TYPE I (Normal) tapes.  P.20

Remote control unit & others

Remote control does not work.	<ul style="list-style-type: none"> ● Function has not been selected properly. ● Batteries are dead or no batteries in the remote control unit. ● Poor angle or too great a distance from the remote sensor window. ● There is an obstacle between you and the remote sensor window. ● A fluorescent light is shining on the remote sensor window. 	<ul style="list-style-type: none"> ● Select the component you wish to operate. ● Insert new batteries.  P.5 ● Use within 7 meters (23 feet) and within a 30 degree angle of the remote sensor window.  P.5 ● Change your position or move the obstacle.  P.5 ● Turn off the light.
Timer does not work	<ul style="list-style-type: none"> ● Current time is not set. ● The TIMER ON/OFF button is set to the OFF position. 	<ul style="list-style-type: none"> ● Set the current time. ● Set to the ON position.  P.24

Abnormal functioning of this unit may be caused by static electricity or other external interference. To restore normal operation, turn the power off and then on again, or unplug the AC power cord and then plug it in again.